

INSTALLATION MANUAL

MITSUBISHI HEAVY INDUSTRIES

Air to Water Heat Pump using R32 refrigerant

Hydrolution (HM)

HSB60-W/FDCW60VNX-W

HSB100-W/FDCW71VNX-W

PT300/PT500/RC-HY20-W/RC-HY40-W

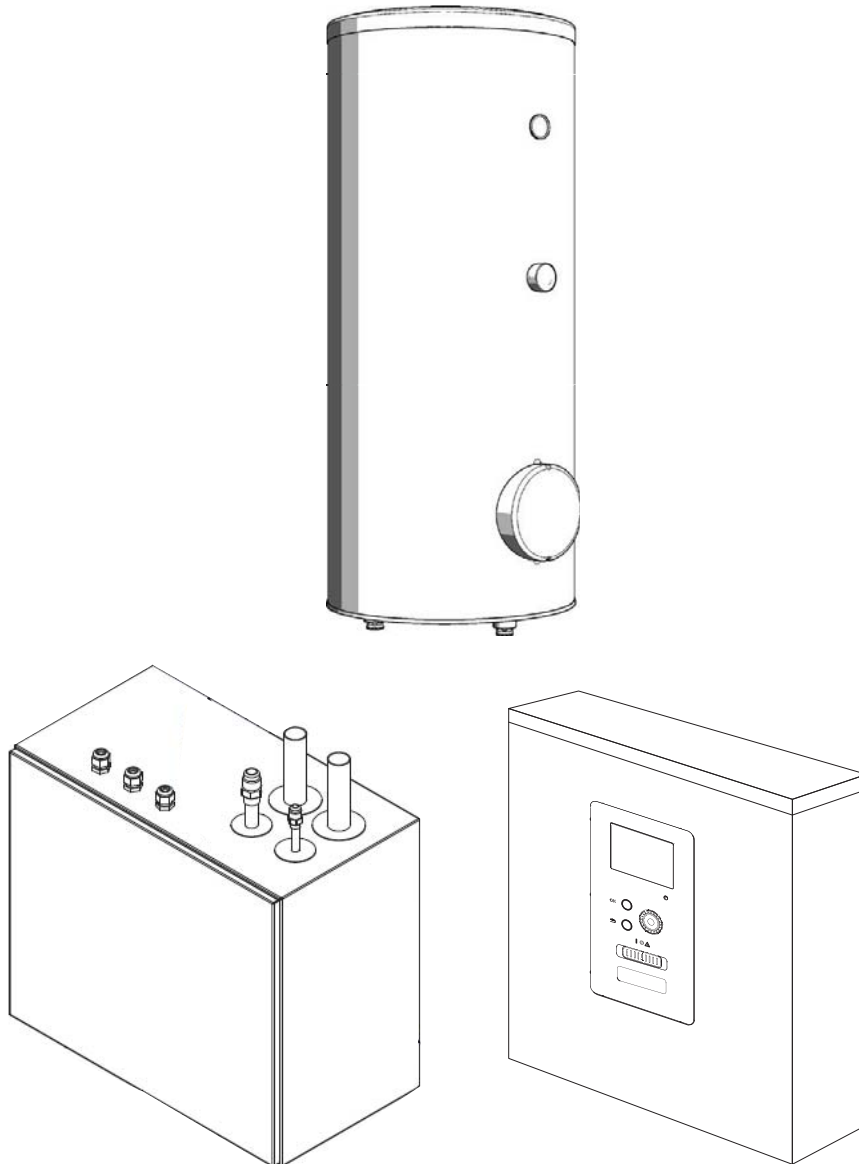

This heat pump complies with EMC Directive 2004/108/EC (replaced by 2014/30/EU on 20/4/2016), LV Directive 2006/95/EC (replaced by 2014/35/EU on 20/4/2016).
CE marking is applicable to the area of 50 Hz power supply.
This heat pump complies with EMC S.I. 2016/1091, EER S.I. 2016/1101.
UKCA marking is applicable to the area of 50Hz power supply.

English : Original instruction

PSC012D169

202201

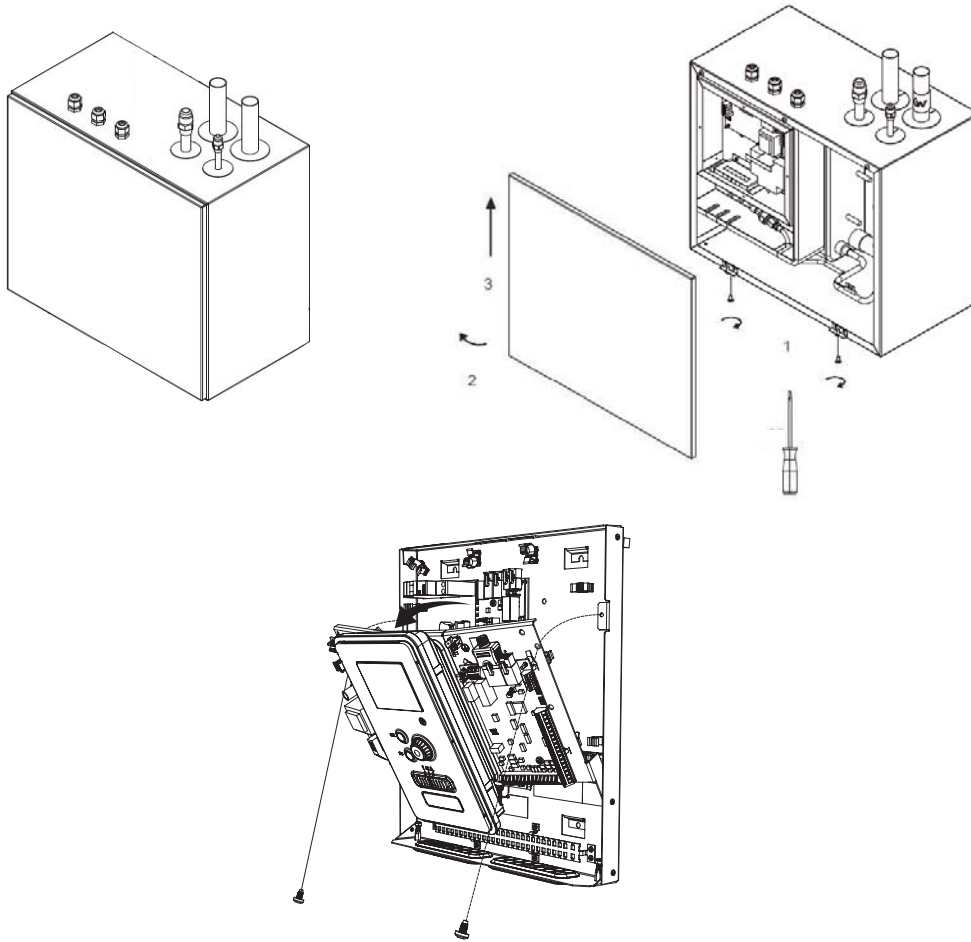

FDCW60VNX-W

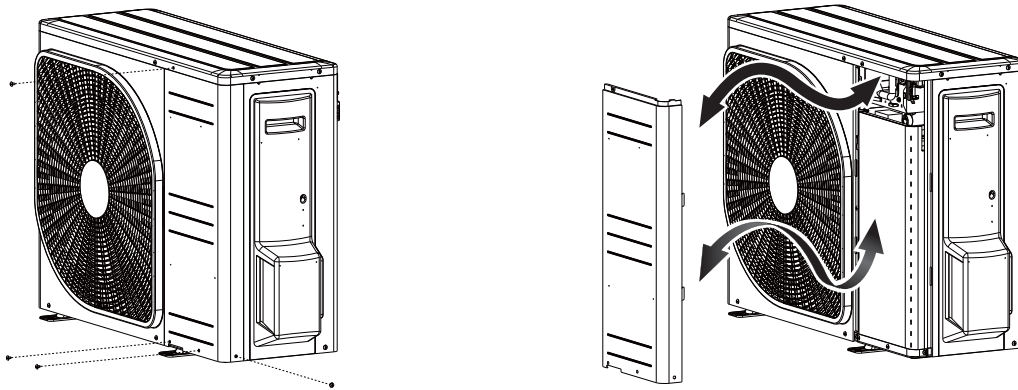

FDCW71VNX-W

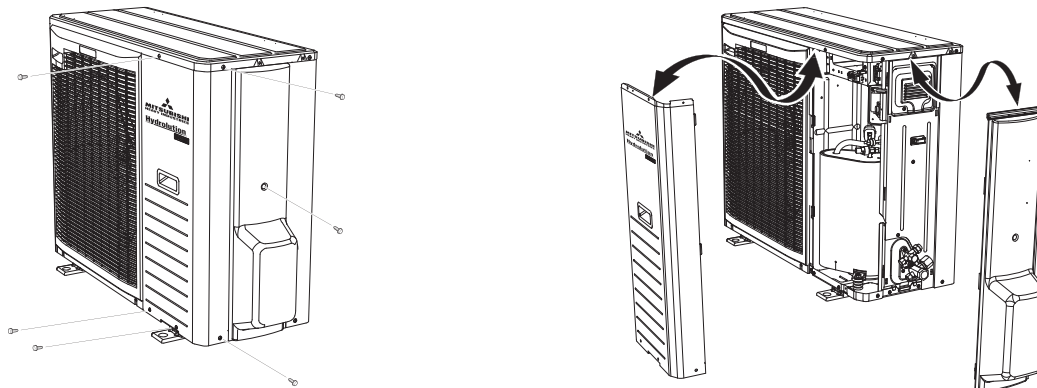





Safety precautions	2		
General information for installer	8		
Over view and design	8		
Transport and storage	10		
Supplied components	10		
Assembly	10		
Hanging indoor unit	12		
Hanging control unit	13		
Dimensioning expansion vessel	13		
Recommended installation order	13		
Selection of installation location for the indoor unit	13		
Pipe installation	15		
General	15		
Installation diagram	15		
HSB60/100-W	15		
System requirements	16		
Overflow valve	16		
Pump capacity diagram	16		
Pressure drop in indoor unit	16		
Dimensions and pipe connections	17		
HSB60/100-W	17		
PT300/500	17		
Water circuit	18		
Connection to heating system	18		
Connection to hot water heater	18		
Housing disassembly of tank unit	18		
Connecting hot water tank to indoor unit	19		
Connecting hot water tank to water main	20		
Hot water circulation circuit	21		
Connection of external heat source	21		
Refrigerant circuit	21		
Connecting refrigerant pipes	21		
Piping insulation	21		
Dockings	22		
Electrical installation	26		
General	26		
Electrical components	27		
Accessibility, electrical connection for controller	28		
Cable lock	30		
Connection for HSB60/100-W	30		
Power supply	30		
Connection between indoor and outdoor unit	30		
Cascade connection setting	31		
Recommended fuse size	31		
Recommended cable size	31		
RC-HY20/40-W	31		
Power source	31		
RC-HY20-W	32		
Connection between controller and indoor unit	32		
Connection between controller and circulation pump (GP12)	32		
Connection between controller and 3 way valve (QN10/QN12)	32		
Connection between controller and sensors	33		
Optional connections	34		
• Room sensor BT50	34		
• Step controlled additional heat	35		
• Relay output for emergency mode	35		
• External circulation pump	36		
• AUX inputs	36		
• AUX outputs	37		
• myUpway™	37		
RC-HY40-W	38		
Connection between controller and indoor unit	38		
Connection between controller and circulation pump (GP12)	38		
Connection between controller and sensors	39		
Optional connections	40		
• Load monitor	40		
• Room sensor BT50	40		
• Step controlled additional heat	40		
• Relay output for emergency mode	40		
• External circulation pump	40		
• AUX inputs	41		
• AUX outputs	41		
		• myUpway™	41
Commissioning and adjusting	42		
Preparations	42		
Filling and venting	42		
Hot water tank	42		
Climate system	42		
Inspection of installation	42		
Start-up and inspection	43		
Before start-up	43		
Commissioning with heat pump	43		
Commissioning with additional heater only	43		
3-way valve operation check	43		
AUX function check	43		
Cooling mode	43		
Cleaning particle filter	43		
Secondary adjustment	43		
Start guide	44		
Start guide - RC-HY20-W	45		
Start guide - RC-HY40-W	48		
Heating/cooling curve setting	52		
Hot water circulation setting	53		
SG Ready	54		
Control	55		
Display unit	55		
Menu system	56		
Menu list	59		
Menu 1 – INDOOR CLIMATE	59		
Menu 2 – HOT WATER	59		
Menu 3 – INFO	59		
Menu 4 – MY SYSTEM	59		
Menu 5 – SERVICE	60		
Sub-menus (Menu 5 - Service)	62		
Service	69		
Disturbances in comfort	73		
Manage alarm	73		
Troubleshooting	73		
Additional heating only	75		
Alarm list	76		
Accessories	90		
Technical data	91		
Electrical circuit diagram	91		
HSB60/100-W	91		
RC-HY20-W	92		
RC-HY40-W	96		



Safety precautions



When installing the unit, be sure to check whether the selection of installation place, power supply specifications, usage limitation (piping length, height differences between indoor and outdoor units, power supply voltage and etc.) and installation spaces.



- We recommend you to read this “SAFETY PRECAUTIONS” carefully before installation in order to gain full advantage of the functions of the unit and to avoid malfunction due to mishandling.

- The precautions described below are divided into  WARNING and  CAUTION. The matters with possibilities leading to serious consequences such as death or serious personal injury due to erroneous handling are listed in the  WARNING and the matters with possibilities leading to personal injury or damage of the unit due to erroneous handling including probability leading to serious consequences in some cases are listed in  CAUTION. These are very important precautions for safety. Be sure to observe all of them without fail.

- The symbols used throughout the main text of this manual have the following meaning.

  marks mean danger, alarm, and caution. The specified prohibited item is described in the triangle. The left mark means “Shock hazard alarm”.

  marks mean prohibited items. The specified prohibited item is described in the circle or in the vicinage.

  marks mean compulsory action or instruction. The specified prohibited item is described in the circle. The left mark means “Earth is needed”.

 The user’s manual should be read carefully.

 There is information included in the user’s manual and/or installation manual.



A service personnel should be handing this equipment with reference to the installation manual .

NOTE

This indicates danger to machine or person.

Caution

This indicates important information about what you should observe when maintaining your installation.

TIP

This indicates tips on how to facilitate using the product.

- Be sure to confirm no anomaly on the equipment by commissioning after completed installation and explain the operating methods as well as the maintenance methods of this equipment to the user according to the owner’s manual.
- Keep the installation manual together with owner’s manual at a place where any user can read at any time. Moreover if necessary, ask to hand them to a new user.

This appliance is designed for use in a home environment and can be used by children aged from 8 years and above and persons with reduced physical, sensory or mental capabilities or lack of experience and knowledge if they have been given supervision or instruction concerning use of the appliance in a safe way and understand the hazards involved. Children shall not play with the appliance. Cleaning and user maintenance shall not be made by children without supervision.

This appliance is also intended for use by experts or trained users in shops, hotels, light industry, on farms and in similar environments.

Following precaution is only for R32.



This equipment uses flammable refrigerants. If the refrigerant is leaked, together with an external ignition source, there is a possibility of ignition.

⚠ DANGER

Strict compliance of the domestic laws must be observed when disposing the appliance. 

Do not use means to accelerate the defrosting process or to clean, other than those recommended by the manufacturer. 

The appliance shall be stored in a room without continuously operating ignition sources (for example: open flames, an operating gas appliance or an operating electric heater). 

Do not pierce or burn. 

Be aware that refrigerants may not contain an odour. 

The appliance shall be stored in a well-ventilated area where the room size corresponds to the room area as specified for operation. 

The staff in servicing operations must hold the national qualification or other relevant qualifications. 

This unit should be installed in rooms which exceed the floor space specified in installation sheets of indoor/outdoor unit. 

Refer to the installation sheet.

⚠ WARNING

Installation must be carried out by the qualified installer. 

If you install the system by yourself, it may cause serious trouble such as water leaks, electric shocks, fire and personal injury, as a result of a system malfunction.

Install the system in full accordance with the instruction manual. 

Incorrect installation may cause bursts, personal injury, water leaks, electric shocks and fire.

Check the density referred by the formula (accordance with ISO5149). 

If the density exceeds the limit density, please consult the dealer and installate the ventilation system.

Use the original accessories and the specified components for installation. 

If parts other than those prescribed by us are used, It may cause water leaks, electric shocks, fire and personal injury.

When installing in small rooms, take prevention measures not to exceed the density limit of refrigerant in the event of leakage. 

Consult the expert about prevention measures. If the density of refrigerant exceeds the limit in the event of leakage, lack of oxygen can occur, which can cause serious accidents.

Ventilate the working area well in the event of refrigerant leakage during installation. 

If the refrigerant comes into contact with naked flames, poisonous gas is produced.

In case of R32, the refrigerant could be ignited because of its flammability.

After completed installation, check that no refrigerant leaks from the system. 

If refrigerant leaks into the room and comes into contact with an oven or other hot surface, poisonous gas is produced.

Hang up the unit at the specified points with ropes which can support the weight in lifting for portage. And to avoid jolting out of alignment, be sure to hang up the unit at 4-point support. 

An improper manner of portage such as 3-point support can cause death or serious personal injury due to falling of the unit.

Install the unit in a location with good support. 

Unsuitable installation locations can cause the unit to fall and cause material damage and personal injury.

Ensure the unit is stable when installed, so that it can withstand earthquakes and strong winds. 

Unsuitable installation locations can cause the unit to fall and cause material damage and personal injury.

Ensure that no air enters in the refrigerant circuit when the unit is installed and removed. 

If air enters in the refrigerant circuit, the pressure in the refrigerant circuit becomes too high, which can cause burst and personal injury.

The electrical installation must be carried out by the qualified electrician in accordance with “the norm for electrical work” and “national wiring 

regulation”, and the system must be connected to the dedicated circuit. !

Power supply with insufficient capacity and incorrect function done by improper work can cause electric shocks and fire.

Be sure to shut off the power before starting electrical work. !

Failure to shut off the power can cause electric shocks, unit failure or incorrect function of equipment.

Be sure to use the cables conformed to safety standard and cable ampacity for power distribution work. !

Unconformable cables can cause electric leak, anomalous heat production or fire.

Use the prescribed cables for electrical connection, tighten the cables securely in terminal block and relieve the cables correctly to prevent overloading the terminal blocks. !

Loose connections or cable mountings can cause anomalous heat production or fire.

Arrange the wiring in the control box so that it cannot be pushed up further into the box. Install the service panel correctly. !

Incorrect installation may result in overheating and fire.

Do not perform brazing work in the airtight room. !

It can cause lack of oxygen.

Use the prescribed pipes, flare nuts and tools for R32 or R410A. !

Using existing parts (for R22 or R407C) can cause the unit failure and serious accidents due to burst of the refrigerant circuit.

Tighten the flare nut by using double spanners and torque wrench according to prescribed method. Be sure not to tighten the flare nut too much. !

Loose flare connection or damage on the flare part by tightening with excess torque can cause burst or refrigerant leaks which may result in lack of oxygen.

Do not open the service valves for liquid line and gas line until completed refrigerant piping work, air tightness test and evacuation. !

If the compressor is operated in state of opening service valves before completed connection of refrigerant piping work, air can be sucked into refrigerant circuit, which can cause burst or personal injury due to anomalously high pressure in the refrigerant.

Do not put the drainage pipe directly into drainage channels where poisonous gases such as sulphide gas can occur. !

Poisonous gases will flow into the room through drainage pipe and seriously affect the user's health and safety.

Only use prescribed optional parts. The installation must be carried out by the qualified installer. !

If you install the system by yourself, it can cause serious trouble such as water leaks, electric shocks, fire.

Do not run the unit with removed panels or protections ⚠

Touching rotating equipments, hot surfaces or high voltage parts can cause personal injury due to entrapment, burn or electric shocks.

Be sure to fix up the service panels. ⚠

Incorrect fixing can cause electric shocks or fire due to intrusion of dust or water.

Do not perform any repairs or modifications by yourself. Consult the dealer if the unit requires repair. ⚠

If you repair or modify the unit, it can cause water leaks, electric shocks or fire.

Do not perform any change of protective device itself or its setup condition !

The forced operation by short-circuiting protective device of pressure switch and temperature controller or the use of non specified component can cause fire or burst.

Be sure to switch off the power supply in the event of installation, inspection or servicing. !

If the power supply is not shut off, there is a risk of electric shocks, unit failure or personal injury due to the unexpected start of fan.

Consult the dealer or an expert regarding removal of the unit. !

Incorrect installation can cause water leaks, electric shocks or fire.

Stop the compressor before disconnecting refrigerant pipes in case of pump down operation. !

If disconnecting refrigerant pipes in state of opening service valves before compressor stopping, air can be sucked, which can cause burst or personal injury due to anomalously high pressure in the refrigerant circuit.

⚠ CAUTION

Carry out the electrical work for ground lead with care. !

Do not connect the ground lead to the gas line, water line, lightning conductor or telephone line's ground lead. Incorrect grounding can cause unit faults such as electric shocks due to short-circuiting.

Use an all-pole circuit breaker with a contact gap of 3 mm or more. 

This provides complete disconnection under Overvoltage Category III. If the breaker does not have sufficient breaking capacity, it can cause the unit malfunction and fire.

Earth leakage breaker must be installed. 

If the earth leakage breaker is not installed, it can cause electric shocks.

Do not use any materials other than a fuse with the correct rating in the location where fuses are to be used. 

Connecting the circuit with copper wire or other metal thread can cause unit failure and fire.

Do not install the unit near the location where leakage of combustible gases can occur. 

If leaked gases accumulate around the unit, it can cause fire.

Do not install the unit where corrosive gas (such as sulfurous acid gas etc.) or combustible gas (such as thinner and petroleum gases) can accumulate or collect, or where volatile combustible substances are handled. 

Corrosive gas can cause corrosion of heat exchanger, breakage of plastic parts and etc. And combustible gas can cause fire.

Secure a space for installation, inspection and maintenance specified in the manual. 

Insufficient space can result in accident such as personal injury due to falling from the installation place.

When the outdoor unit is installed on a roof or a high place, provide permanent ladders and handrails along the access route and fences and handrails around the outdoor unit. 

If safety facilities are not provided, it can cause personal injury due to falling from the installation place.

Do not use the indoor unit at the place where water splashes may occur. 

Since the indoor unit is not waterproof, it can cause electric shocks and fire.

Check that there is no water leakage from the water circuit before starting commissioning.

If there is water leakage you may get scalded by hot water. There is also a risk that the indoor unit or electric equipment will be damaged by the water.

Do not install or use the system close to the equipment that generates electromagnetic fields or high frequency harmonics. 

Equipment such as inverters, standby generators, medical high frequency equipments and telecommunication equipments can affect the system, and cause malfunctions and breakdowns. The system can also affect medical equipment and telecommunication equipment, and obstruct its function or cause jamming.

Do not install the outdoor unit in a location where insects and small animals can inhabit. 

Insects and small animals can enter the electric parts and cause damage or fire. Instruct the user to keep the surroundings clean.

Do not use the base flame for outdoor unit which is corroded or damaged due to long periods of operation. 

Using an old and damage base flame can cause the unit falling down and cause personal injury.

Do not install the unit in the locations listed below. 

- Locations where carbon fiber, metal powder or any powder is floating.
- Locations where any substances that can affect the unit such as sulphide gas, chloride gas, acid and alkaline can occur.
- Vehicles and ships.
- Locations where cosmetic or special sprays are often used.
- Locations with direct exposure of oil mist and steam such as kitchen and machine plant.
- Locations where any machines which generate high frequency harmonics are used.
- Locations with salty atmospheres such as coastlines.
- Locations with heavy snow (If installed, be sure to provide base flame and snow hood mentioned in the manual).
- Locations where the unit is exposed to chimney smoke.
- Locations at high altitude (more than 1000m high).
- Locations with ammoniac atmospheres.
- Locations where heat radiation from other heat source can affect the unit.

Safety precautions

- Locations without good air circulation.
- Locations with any obstacles which can prevent inlet and outlet air of the unit.
- Locations where short circuit of air can occur (in case of multiple units installation).
- Locations where strong air blows against the air outlet of outdoor unit.

It can cause remarkable decrease in performance, corrosion and damage of components, malfunction and fire.

Do not install the outdoor unit in the locations listed below.

- Locations where discharged hot air or operating sound of the outdoor unit can bother neighborhood.
- Locations where outlet air of the outdoor unit blows directly to plants.
- Locations where vibration can be amplified and transmitted due to insufficient strength of structure.
- Locations where vibration and operation sound generated by the outdoor unit can affect seriously. (on the wall or at the place near bed room)
- Locations where an equipment affected by high harmonics is placed. (TV set or radio receiver is placed within 5m)
- Locations where drainage cannot run off safely.

It can affect surrounding environment and cause a claim.

Do not install the remote controller at the direct sunlight.

It can cause malfunction or deformation of the remote controller.

Do not use the unit for special purposes such as storing foods, cooling precision instruments and preservation of animals, plants or art.

It can cause the damage of the items.

Take care when carrying the unit by hand.

Avoid dropping the unit during transportation. If the unit weights more than 20kg, it must be carried by two or more persons. Do not carry by the plastic straps, always use the carry handle when carrying the unit by hand. Use gloves to minimize the risk of cuts by the aluminum fins.

Dispose of any packing materials correctly.

Any remaining packing materials can cause personal injury as it contains nails and wood. And to avoid danger of suffocation, be sure to keep the plastic wrapper away from children and to dispose after tear it up.

Pay attention not to damage the drain pan by weld spatter when welding work is done near the indoor unit.

If weld spatter entered into the indoor unit during welding work, it can cause pin-hole in drain pan and result in water leakage. To prevent such damage, keep the indoor unit in its packing or cover it.

Be sure to insulate the refrigerant pipes so as not to condense the ambient air moisture on them.

Insufficient insulation can cause condensation, which can lead to moisture damage on the ceiling, floor, furniture and any other valuables.

Be sure to perform air tightness test by pressurizing with nitrogen gas after completed refrigerant piping work.

If the density of refrigerant exceeds the limit in the event of refrigerant leakage in the small room, lack of oxygen can occur, which can cause serious accidents.

Do not touch any buttons with wet hands.

It can cause electric shocks.

Avoid damage by metal edge or trapped by panels.

Broken wire can cause unit faults such as electric shock due to short circuiting.

Do not shut off the power supply immediately after stopping the operation.

Wait at least 5 minutes, otherwise there is a risk of water leakage or breakdown.

Do not control the system with main power switch.

It can cause fire or water leakage. In addition, the fan can start unexpectedly, which can cause personal injury.

Do not touch any refrigerant pipes when the system is in operation.

During operation the refrigerant pipes become extremely hot or extremely cold depending the operating condition, and it can cause burn injury or frost injury.

Do not clean up the machines with water.

It could cause electric shock.

If the supply cord is damaged, it must be replaced by the manufacturer, its service agent or similarly qualified persons in order to avoid a hazard.

Disposal and cleaning of refrigerant should be handled by a qualified specialist.

Contact the sales company for details.

Notabilia for units designed for R32

- Do not use any refrigerant other than R32. R32 will rise to pressure about 1.6 times higher than that of a conventional refrigerant (R22 or R407C). A cylinder containing R32 has a light blue indication mark on the top.
- In charging refrigerant, always take it out from a cylinder in the liquid phase.
- All indoor units must be models designed exclusively for R32. Check connectable indoor unit models in a catalog, etc. (A wrong indoor unit, if connected into the system, will impair proper system operation)

Dedicated tools for R32 or R410A	
a)	Gauge manifold
b)	Charge hose
c)	Electronic scale for refrigerant charge
d)	Vacuum pump
e)	Flaring tool set
f)	Protrusion control gauge for copper pipe
g)	Vacuum pump adapter
h)	Gas leak detector

General information for installer

For outdoor unit installation information, see Installation manual for Outdoor unit.

Over view and design

HSB60/100-W

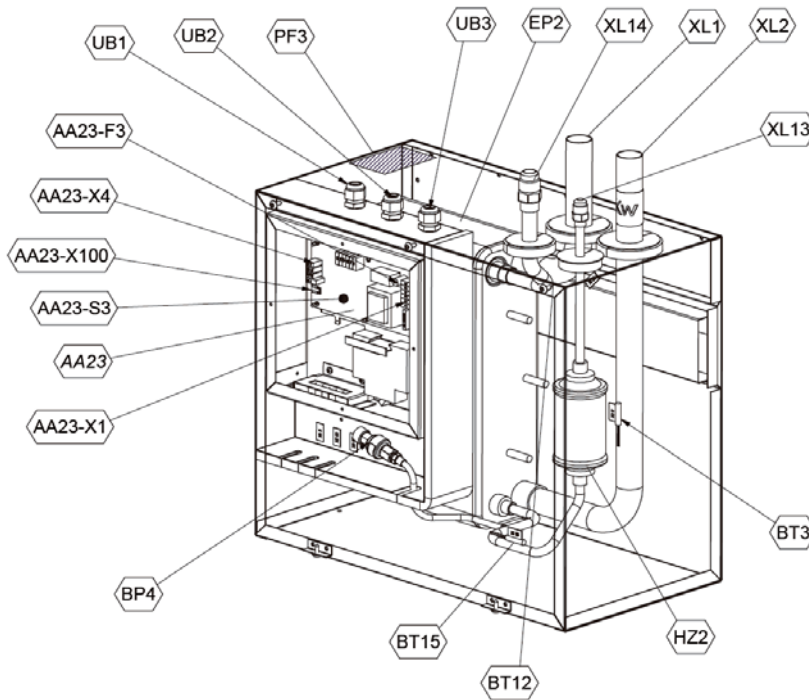

Pipe connections

XL1 (Red mark)	Climate system supply
XL2 (Blue mark)	Climate system return
XL14	Connection, gas line
XL13	Connection, liquid line

Valves etc.

EP2	Heat exchanger
HQ1	Particle filter (supplied)
HZ2	Drying filter

Electrical components

AA23	Communication board
AA23-F3	Fuse for external heating cable
AA23-S3	DIP switch, addressing of outdoor unit
AA23-X1	Terminal block, incoming supply, connection of KVR
AA23-X4	Terminal block, communication with indoor module / control module
AA23-X100	Terminal block, communication outdoor module

Sensor, thermostats

BP4	Pressure sensor, high pressure
BT3	Temperature sensor, heating medium, return
BT12	Temperature sensor, condenser, supply
BT15	Temperature sensor, fluid pipe

Miscellaneous

UB1	Cable gland
UB2	Cable gland
UB3	Cable gland

PT300/500

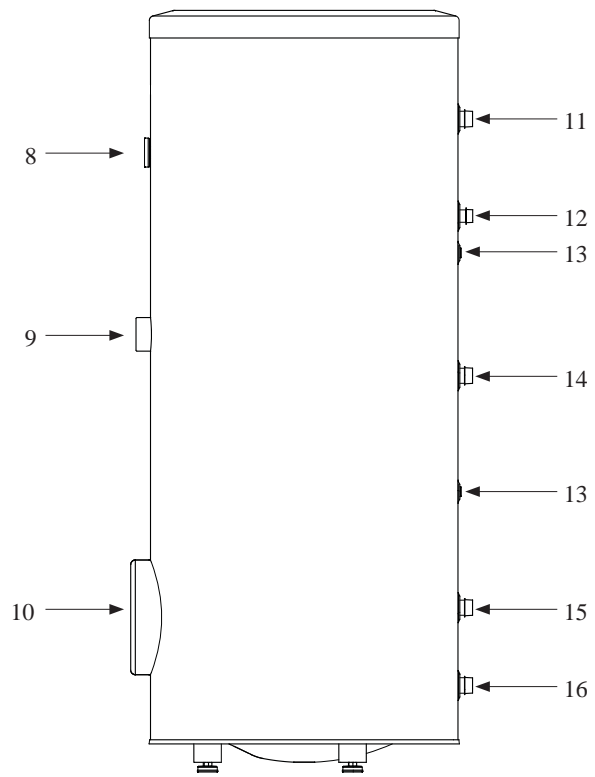
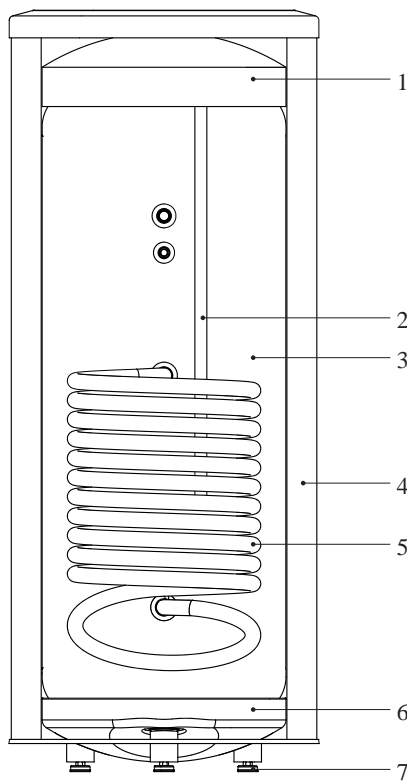

Section of the PT300/500 storage tanks.

1. Upper insulation of the storage tank
2. Protective magnesium anode
3. Enamelled tank
4. Side insulation of the storage tank
5. Coil
6. Lower insulation of the storage tank
7. Adjustable foot

Side view of the PT300/500 storage tanks.

8. Thermometer
9. Connector pipe for mounting electric heating unit
10. Inspection opening
11. Hot water intake connector pipe
12. Hot water circulation connector pipe
13. Temperature sensor cover
14. Coil supply connector pipe
15. Connection of return line from the coil
16. Cold water supply connector pipe

Transport and storage

Indoor unit and tank unit must be transported and stored vertically in dry conditions.

Supplied components

HSB60/100-W Indoor unit

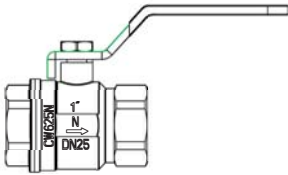

Particle filter R25 (HQ1).

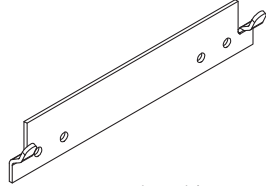

Brackets kit



Flare reduction (HSB100-W only)

Replace by 3/8" flare on HSB when outdoor unit is FDCW71VNX-W

RC-HY20/40-W Control unit



Outside sensor



Room sensor (RC-HY40-W only)

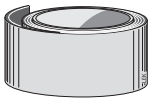

Insulation tape



Temperature sensor

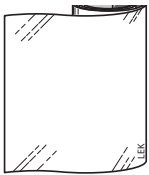

Aluminium tape



Cable ties



Heating pipe paste



Current sensor (RC-HY40-W only)

Assembly

- It is recommended that indoor unit is installed in a room with existing floor drainage, most suitably in a utility room or boiler room.
- For indoor unit and control unit, the mounting surface must be firm, flat and vertical, preferably a concrete wall.
- Tank unit must be set on a solid waterproof base that would keep the weight of the unit. The height-adjusting legs allow for levelling and stable setting.

PT300/500

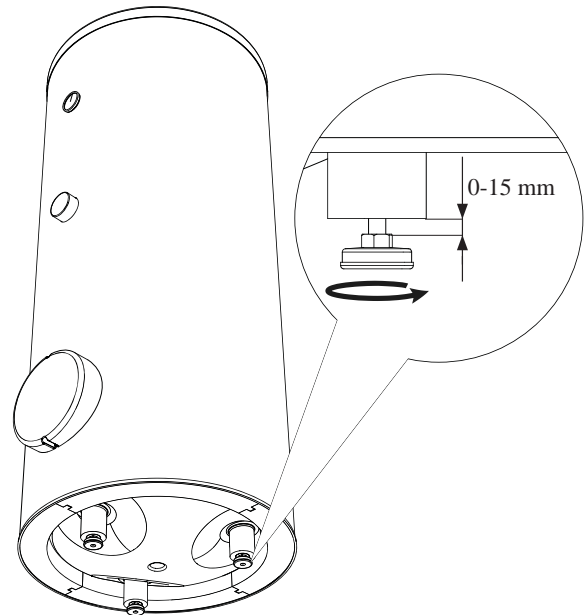

- Install indoor unit with its back to an outside wall, ideally in a room where noise does not matter. If this is not possible, avoid placing it against a wall behind a bedroom or other room where noise may be a problem.
- Route pipes so they are not fixed to an internal wall that backs on to a bedroom or living room.
- Install tank unit and its pipings to indoor unit indoors in order to avoid icing.
- Ensure free space described in the following figures for future maintenance.

HSB60/100-W

Recommendation for positioning on wall

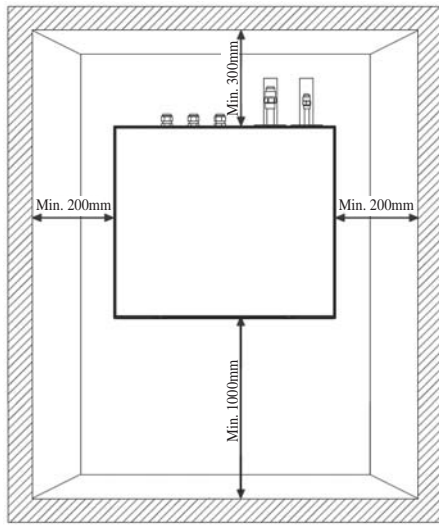

Recommendation for positioning in corner

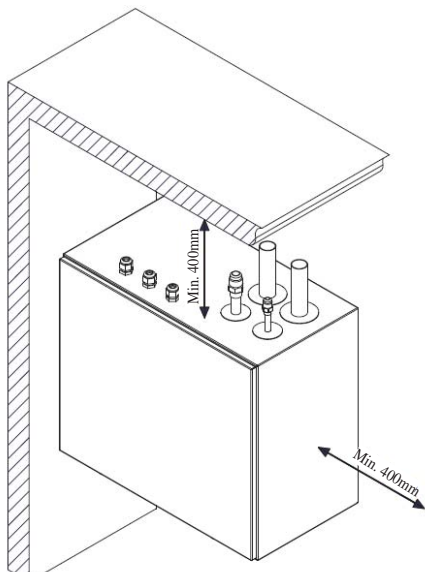

*Min 800mm is required in front

PT300/500

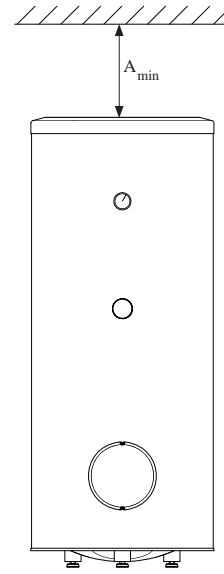

A_{min} is required on top to replace anode bar, and 500 mm is required in front to replace immersion heater if equipped.

Application	Connector pipe dia.	Type of anode	A _{min}
PT300	1"	Chain ø26 × 8	150 mm
	¾"	Titanium anode	200 mm
PT500	1¼"	Chain ø33 × 5	150 mm
	¾"	Titanium anode	400 mm

RC-HY20/40-W

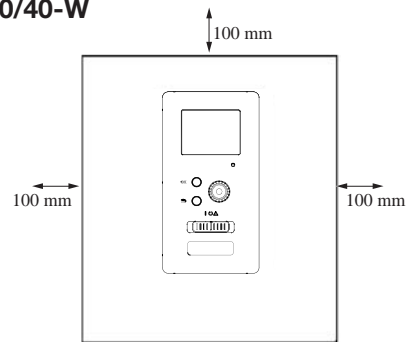

Hanging indoor unit

It is recommended that the split box is installed in a room with existing floor drainage, most suitably in a utility room or boiler room.

1. The bracket for the split box is mounted to the wall by use of appropriate screws.

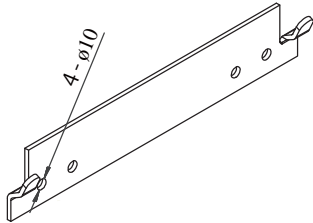

2. Insert the split box in the bracket mounted to the wall.

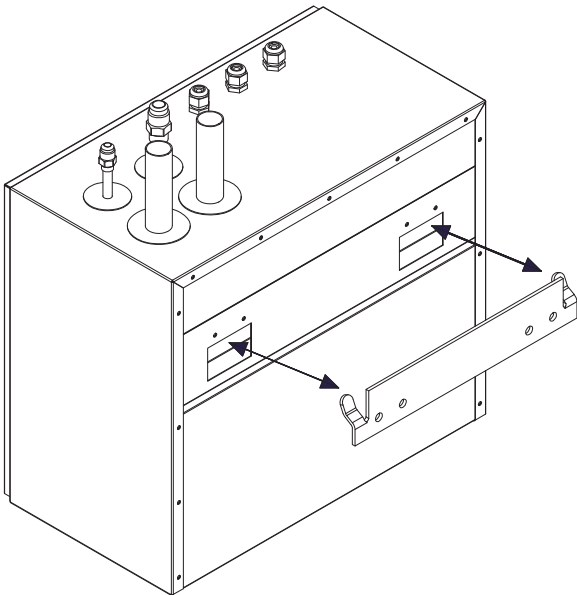

NOTE

Indoor unit weigh A kg excluding water inside.

	A
HSB60-W	16
HSB100-W	18

Hanging control unit

Use all mounting points and install control unit upright against a flat wall. Make sure whole back surface faces the wall.

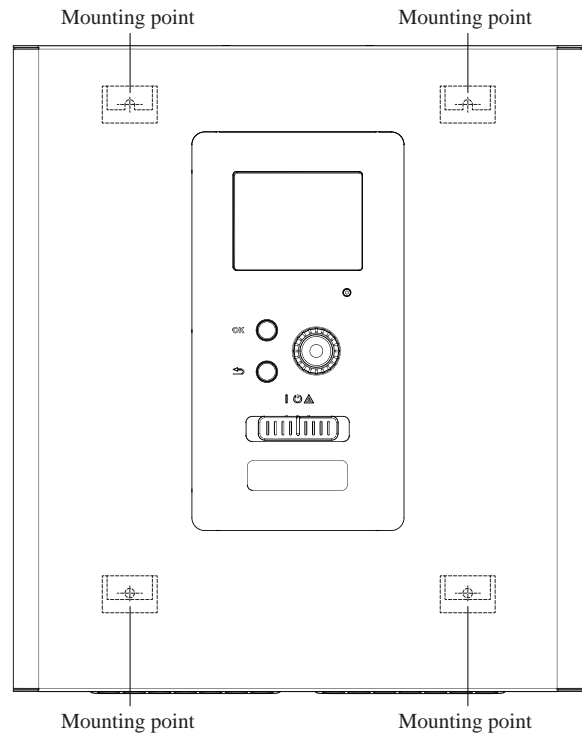

Dimensioning expansion vessel

The expansion vessel volume must be at least 5% of total water volume in the circulation system.

Initial pressure and max height difference

Recommended maximum height difference between expansion vessel and the highest point in the system is 5m.

The initial pressure of the pressure expansion vessel must be dimensioned according to the maximum height (H) between the vessel and the highest positioned radiator, see figure. An initial pressure of 0.5 bar (5 mvp) means a maximum permitted height difference of 5 m.

If the standard initial pressure in the pressure vessel is not high enough it can be increased by filling via the valve in the expansion vessel. The expansion vessel's standard initial pressure must be entered in the check list on User's manual.

Any change in the initial pressure affects the ability of the expansion vessel to handle the expansion of the water.

Consult local distributor in case height difference exceeds 5m.

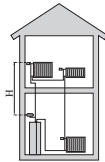

Recommended installation order

1. Hang indoor unit and control unit to appropriate position and connect indoor unit and tank unit.
2. Connect indoor unit to climate system, cold and hot water lines as well as any external heat sources. See page 15. Also see docking descriptions on page 24, 25 and further on.
3. Install refrigerant pipes according to the description on the Installation manual for outdoor unit.
4. Connect current limiter, any centralised load control and external contacts as well as the cable between indoor unit and outdoor unit.
5. Connect incoming electricity to indoor unit and/or outdoor unit. See page 30, 31.
6. Follow the commissioning instructions on page 32-41.

Selection of installation location for the indoor unit

- If the total refrigerant charge in the system (m_c) is $\leq 1.84\text{kg}$, no restriction applies for the installation room area (A_{room}).
- If the total refrigerant charge in the system (m_c) is $> 1.84\text{kg}$, minimum installation room area ($A_{\text{min, total}}$) and maximum refrigerant charge (m_{max}) restrictions apply. The following steps must be followed.

1) Check m_{max} in the installation room area (A_{room})

(a) Measure installation room area (A_{room})

(b) Check m_{max} which correspond to the A_{room} based on the table 1.

(c-1) When $m_{\text{max}} \geq m_c$, the unit can be installed in the installation room area (A_{room}) without any further room size or ventilation requirements.

(c-2) When $m_{\text{max}} < m_c$, further requirements are necessary. Please proceed to the next step.

2) Check the total minimum floor area ($A_{\text{min total}}$)

(a) Measure area of adjacent room B (B_{room})

(b) Check $A_{\text{min total}}$ for total refrigerant charge in the system

(c-1) When $A_{\text{min total}} > A_{\text{room}} + B_{\text{room}}$, other requirements are necessary. Please contact your dealer.

(c-2) When $A_{\text{min total}} \leq A_{\text{room}} + B_{\text{room}}$, unit can be installed in the room A if complies with the next step.

3) Make two permanent openings (one lower, a second higher), between A_{room} and B_{room}

(a) Check the minimum opening area (Anv_{min}) for natural ventilation based on table 3.

(b) The two permanent openings must meet the below conditions.

Lower opening

- The area of any openings above 300 mm from the floor shall not be considered in determining compliance with Anv_{min} .
- The bottom of the opening must not be $>$ unit point of release and not $>$ 100mm from the floor.
- At least 50% of the required opening area Anv_{min} shall be below 200mm from the floor.
- Opening are permanent openings which cannot be closed.
- The height of the opening between wall and floor which connect the rooms are not less than 20mm.

Second higher opening

- The total size of the opening must be $\geq 50\%$ of Anv_{min}
- The bottom of the opening must be situated $\geq 1500\text{mm}$ from the floor.
- The requirement for the second opening can be met by drop ceilings, ventilation ducts, or similar arrangements that provide an airflow path between the connected rooms.

General information for the installer

Symbol	Description	
m_c	Total refrigerant charge in the system	kg
A_{room}	Installation room area	m ²
M_{max}	Allowable maximum refrigerant charge	kg
B_{room}	Adjacment room area	m ²
$A_{min\ total}$	Required minimum room area	m ²
Δm	$m_c - m_{max}$	kg
Anv_{min}	Minimum ventilation opening area	cm ²

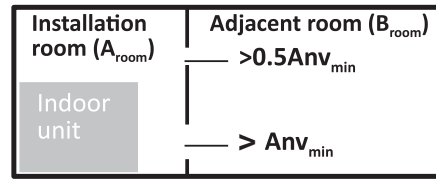

Total refrigerant charge in the system (m_c)
 = factory refrigerant charge + additional refrigerant charge

Table1. Maximum refrigerant charge

A_{room} (m ²)	Maximum refrigerant charge (M_{max}) (kg)	
	H=1.0 m	H=1.8 m
1	0.230	0.414
2	0.461	0.829
3	0.691	1.243
4	0.921	1.658
5	1.151	2.072
6	1.382	2.487
7	1.512	2.721
8	1.616	2.909
9	1.714	3.085
10	1.807	3.252
11	1.895	3.411
12	1.979	3.562
13	2.060	3.708
14	2.138	3.848
15	2.213	3.983
16	2.285	4.113
17	2.356	4.240
18	2.424	4.363
19	2.490	4.482
20	2.555	4.599
21	2.618	4.712
22	2.680	4.823
23	2.740	4.932
24	2.799	5.038
25	2.856	5.142
26	2.913	5.244
27	2.969	5.343
28	3.023	5.441
29	3.077	5.538
30	3.129	5.632

- For AtoW indoor units, installation height is higher than 1000mm to comply with IEC60335-2-40:2018 Clauses GG2.

- "Intermediate" values are rounded as per following examples:

- if $A_{room} = 20.8$ m², then 20 m² is considered in Table 1
- if $m_c = 2.27$ kg, then 2.28 kg is considered in Table 2
- if $(m_c - m_{max}) = 1.5$ kg, then 1.64 kg is considered in Table 3

Table2. Minimum room area

m_c (kg)	Minimum room area ($A_{min\ total}$) (m ²)	
	H=1.0 m	H=1.8 m
1.86	10.60	3.27
1.88	10.83	3.34
1.90	11.06	3.41
1.92	11.29	3.49
1.94	11.53	3.56
1.96	11.77	3.63
1.98	12.01	3.71
2.00	12.26	3.78
2.02	12.50	3.86
2.04	12.75	3.94
2.06	13.00	4.01
2.08	13.26	4.09
2.10	13.51	4.17
2.12	13.77	4.25
2.14	14.03	4.33
2.16	14.29	4.41
2.18	14.56	4.49
2.20	14.83	4.58
2.22	15.10	4.66
2.24	15.37	4.74
2.26	15.65	4.83
2.28	15.93	4.92
2.30	16.21	5.00
2.32	16.49	5.09
2.34	16.78	5.18
2.36	17.06	5.27
2.38	17.36	5.36
2.40	17.65	5.45
2.42	17.94	5.54
2.44	18.24	5.63
2.46	18.54	5.72
2.48	18.84	5.82
2.50	19.15	5.91
2.52	19.46	6.01
2.54	19.77	6.10

- Systems with total refrigerant charge 1.84kg or less are not subjected to any requirements for minimum installation room area.

- Refrigerant charge above 2.54kg is not allowed in the unit.

Table3. Minimum opening area for natural ventilation

m_c (kg)	M_{max} (kg)	$\Delta m = m_c - m_{max}$ (kg)	Minimum opening area (Anv_{min}) (cm ²)
2.54	0.10	2.44	987
2.54	0.30	2.24	906
2.54	0.50	2.04	825
2.54	0.70	1.84	744
2.54	0.90	1.64	682
2.54	1.10	1.44	662
2.54	1.30	1.24	620
2.54	1.50	1.04	559
2.54	1.70	0.84	480
2.54	1.90	0.64	387
2.54	2.10	0.44	280
2.54	2.30	0.24	160
2.54	2.50	0.04	28

Pipe installation

General

Pipe installation must be carried out in accordance with current norms and directives.

A following table shows plumbing necessary for each product.

	Refrigerant	Plumbing
HSB	Necessary	Necessary
PT	—	Necessary
RC-HY	—	—

This heat pump system is designed for low or medium temperature heating system. It is recommended water temperature must not exceed 55°C on supply and 45°C on return at lowest design outdoor temperature (DOT) though

indoor unit can operate with a return temperature of up to 63°C and an outgoing temperature from the unit of 65°C.

Indoor unit is not equipped with shut off valves; these must be installed outside the heat pump to facilitate any future servicing.

Indoor unit can be connected to the radiator system, floor heating system and/or fan convectors.

Safety valve is not equipped with in indoor unit. Make sure to install safety valve in the circuit.

Installation diagram

Outdoor unit provides heat for space heating and domestic hot water using free energy in the outdoor air within the range of low temperature up to -20°C. The system is controlled by RC-HY20-W or RC-HY40-W control unit.

HSB60/100-W

Indoor unit is equipped with plate heat exchanger. It is necessary to install expansion vessel, shut-off valves, safety valve, electric heater and circulation pump to make a complete heating system. In case domestic hot water is required, 3 way valve and tank is also needed.

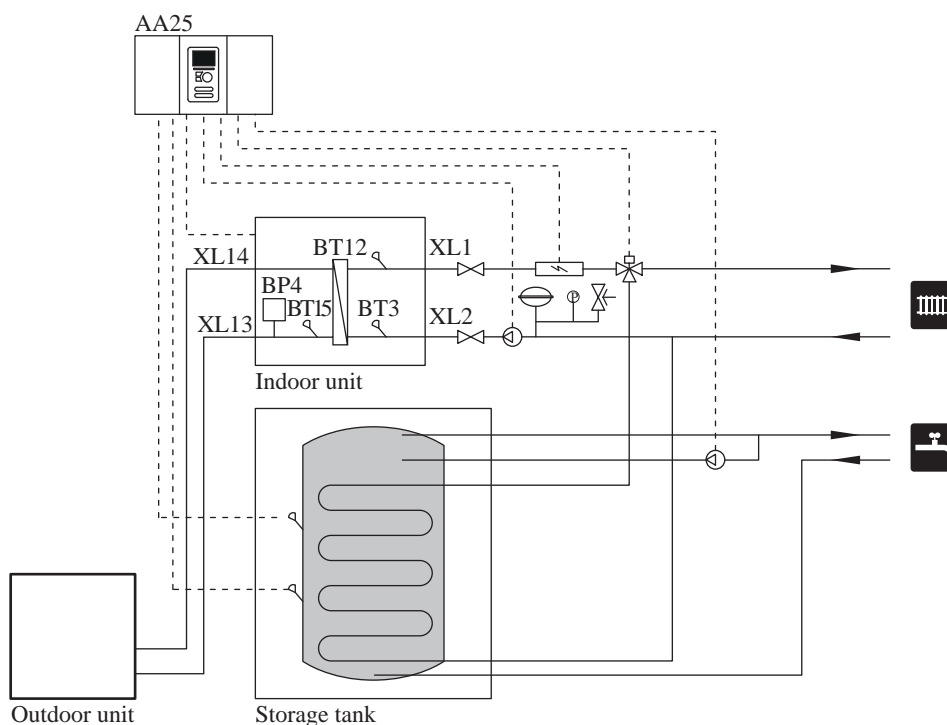

System requirements

The minimum water volume in the climate system is subject to the values in the table below. If it is not fulfilled, volume vessel must be installed.

For more options, see the docking description on Page 22.

(liter)

	With underfloor cooling application	Without underfloor cooling application
HSB60-W, FDCW60VNX-W	80	50
HSB100-W, FDCW71VNX-W	80	50

Overflow valve

NOTE

A free flow is required for all docking options, which means that an overflow valve must be installed.

The circulation pump may become damaged.

Pump capacity diagram

HSB60/100-W

HSB60/100-W is not equipped with circulation pump.

This graph shows the characteristic of CPD11-25M/65 and 75.

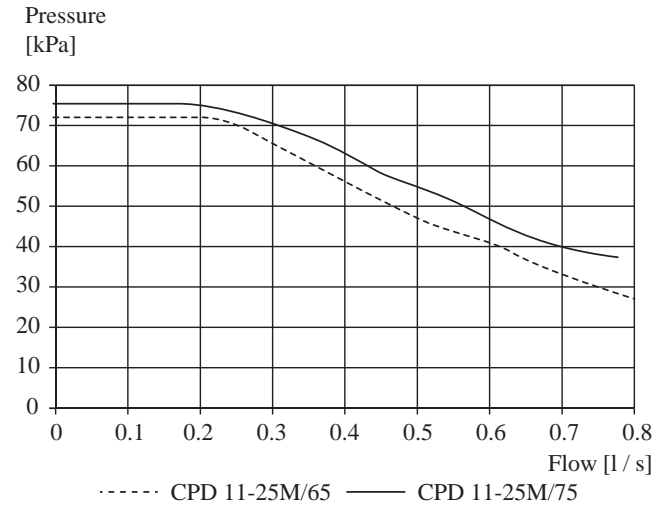

Pressure drop in indoor unit

HSB60/100-W

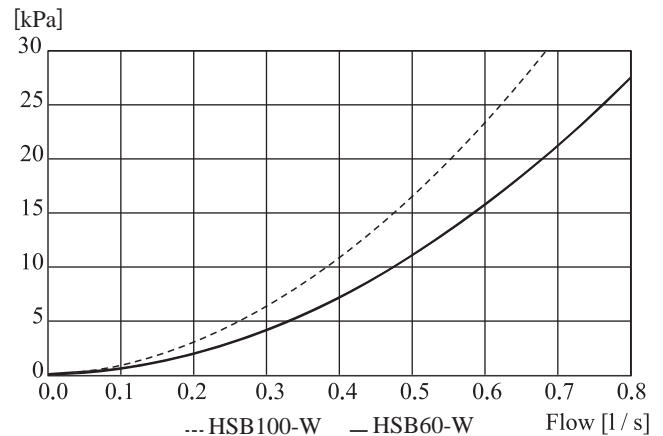

Connection of extra circulation pump

When connecting extra circulation pumps, requirements for pressure, maximum flow etc must be met. See page 24, 25 for location.

NOTE

Non-return valve must be installed in case extra circulation pump is used. See page 24, 25 for the position.

The circulation pump may become damaged.

Dimensions and pipe connections

HSB60/100-W

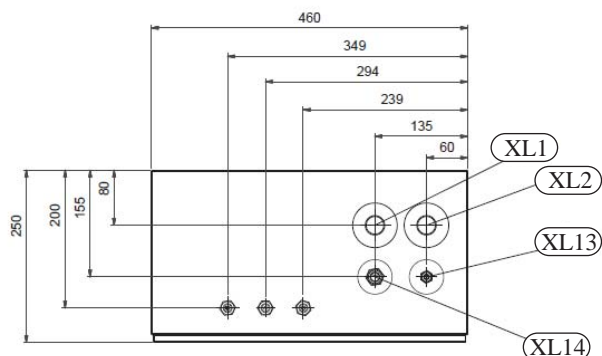

Pipe connections

Symbol		Content	
		HSB60-W	HSB100-W
XL1	Climate system supply	φ 22 mm	φ 28 mm
XL2	Climate system return	φ 22 mm	φ 28 mm
XL13	Connection, liquid line	1/4"	3/8"
XL14	Connection, gas line	1/2"	5/8"

PT300/500

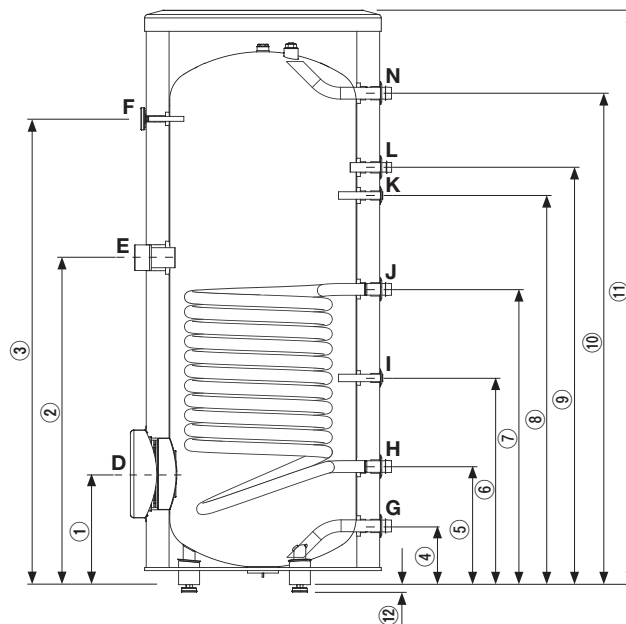

Connection		U/m	PT300/500
D	Inspection opening	mm	φ 120
E	Heating unit connection	inch	1½" Female
F	Thermometer enclosure	mm	φ 10 Female
N	Hot water outlet	inch	1" Male
L	Hot water circulation	inch	¾" Male
K	Temperature sensor enclosure (BT7)	mm	φ 16 Female
J	Coil supply	inch	1" Male
I	Temperature sensor enclosure (BT6)	mm	φ 16 Female
H	Return from coil	inch	1" Male
G	Cold water input	inch	1" Male

Dimensions			
		PT300	PT500
①	mm	315	337
②	mm	930	967
③	mm	1325	1477
④	mm	167	188
⑤	mm	336	288
⑥	mm	588	387
⑦	mm	840	805
⑧	mm	1107	1234
⑨	mm	1187	1302
⑩	mm	1398	1545
⑪	mm	1634	1835
⑫	mm	21-0/+15	

Water circuit

Connection to heating system

Connect XL1 to supply line and X2 to return line from heating system.

- All required safety devices and shut-off valves must be installed as close to the indoor unit as possible.
- Install bleed valves where necessary, highest point of the water system in usual case.
- When connecting to a system with thermostats on all radiators, install an overflow valve or remove some of the thermostats to ensure sufficient flow.
- See section Dockings for outline diagram.
- Install a safety valve with manometer on heating circuit and hot water circuit. (FL2)

For HSB60/100-W install a safety valve for heating circuit on the water pipe returning to indoor unit since it doesn't have port for FL2.

The entire length of the overflow water pipe from the safety valves must be inclined to prevent water pockets and must also be frost proof.

- The end of overflow water pipe from the safety valves must be left open to the atmosphere. The water may drip from the pipe.

Connection to hot water heater

For HSB60/100-W indoor unit, it is necessary to connect PT300/500 tank unit applying 3 way valve in order to use domestic hot water function.

Housing disassembly of tank unit

Removable housing with thermal insulation facilitates transport and installation of the storage tank. Disassembly the housing in the following order (see next page figure):

1. Remove the Temperature gauge, plug of the heating element connector pipe and blanking plate of the inspection opening.
2. Remove the upper cover of the housing together with thermal insulation.
3. Remove the plugs from the connector pipes and black bushings.
4. Remove the fixing screws and the strip connecting the housing jacket.
5. Remove the jacket surrounding the tank (housing jacket.)
6. Remove the four-piece thermal insulation.

After the installation of the storage tank in its final location, reinstall the removed components in the reverse order.

HSB60/100-W

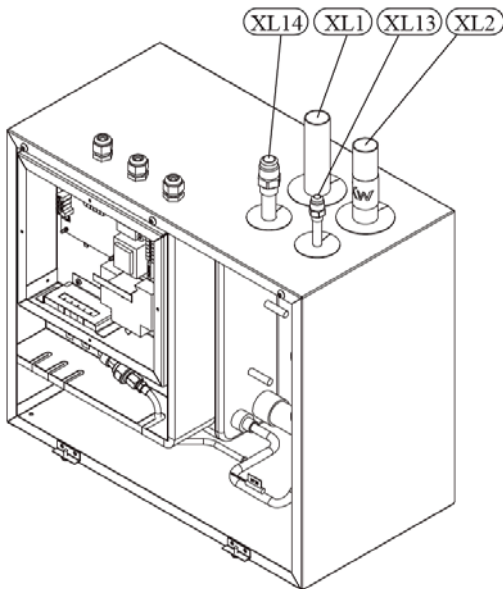

Install safety valve as close to XL2 as possible.

Housing and thermal insulation disassembly

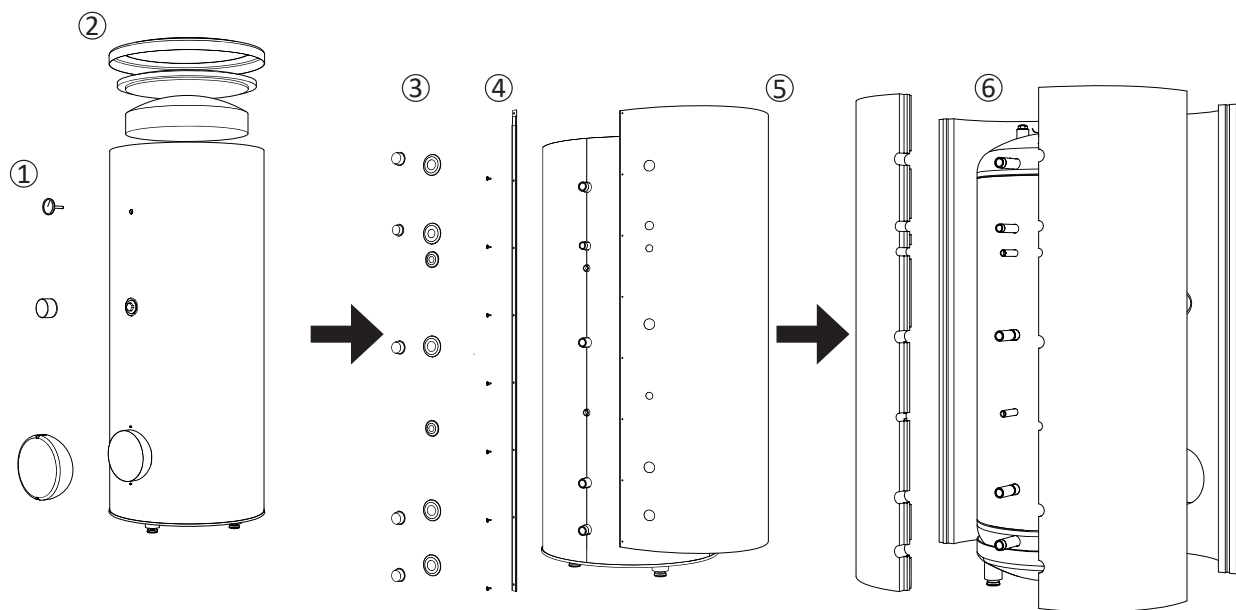

Connecting hot water tank to indoor unit

CAUTION

Installation and commissioning of the storage tank shall only be done by appropriately qualified installer. The installer should inform the user of the functions of the product and provide the necessary information on its safe use.

Information

We recommend installing a strainer in order to protect the pumps, check valve and the components of the heating system.

- Tank and its pipings to indoor unit must be installed indoors where the temperature wouldn't drop below 15°C in order to prevent pipings from icing.
- Maximum piping length between indoor unit and tank is 10m.
- Tank unit should be placed on firm, preferably a concrete floor or foundation.

- Tank unit can be aligned using the adjustable feet.
- Protection against overpressure shall be made in accordance with the relevant regulations.
- Connect the heating system according to the installation diagram (see figure).

Installation diagram of the PT storage tank with one coil.

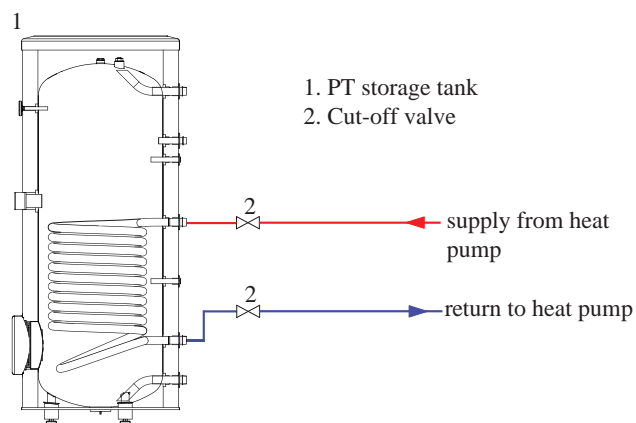

Connecting hot water tank to water main

- Install a mixing valve if the temperature exceeds 60 °C.
- It is recommended to install a thermostatic mixing valve for stable temperature hot water supply.
- Connect the storage tank to the water supply system of water pressure at least 1 bar and max 10 bar. Install a pressure reducer if the pressure at the cold water inlet to the tank is higher than allowed.
- Install a safety valve which have a maximum 8.0 bar opening pressure on the incoming domestic water line according to outline diagram in order to protect the storage tank against overpressure. Pressure increases during heating the water.
- During heating the water, small and temporary water flow from the safety valve can occur, which indicates that the pressure has increased above the rated value, which triggered the valve. This may in no way be prevented.
- Safety valve drain line should be installed with a decline, in an environment free of freezing and remain open to the atmosphere. The manufacturer is not responsible for flooding the room through the safety valve.
- Blocked safety valve can cause equipment failure. Drain the outflow from the safety valve to the sewerage or drain grate.
- See section Dockings for outline diagram.
- Connect the water supply system according to the installation diagram.

Installation diagram of the PT storage tank with one coil.

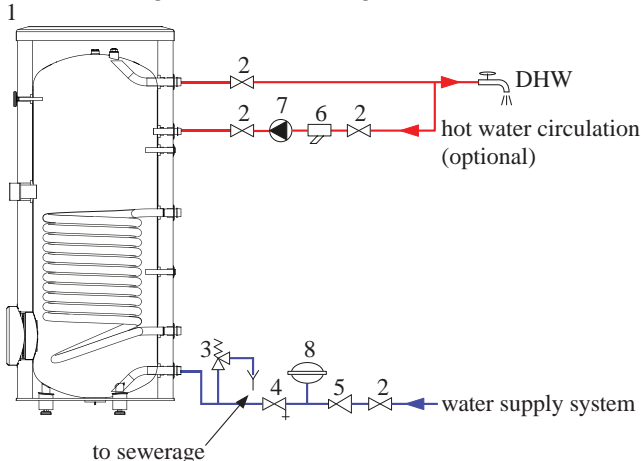

1. PT storage tank
2. Cut-off valve
3. Safety valve
4. Drain valve
5. Pressure reducer (option, if the pressure in the system exceeds the allowable value)
6. Strainer
7. Hot water circulating pump
8. Hot water expansion vessel

Information

In order to minimize the flow of water from the safety valve associated with the thermal expansion of the liquid, it is advisable to install a suitable expansion vessel at the cold water connection (see item 8.)

CAUTION

Installation of the appropriate safety valve in the cold water supply line protecting the unit against overpressure is mandatory!

CAUTION

Installation of necking of any kind (such as reducers, dirt pockets, etc.) and cut-off valves between the storage tank and the safety valve is not allowed. Only a T-pipe with a drain valve and a T-pipe with an expansion vessel may be installed in these line sections.

CAUTION

Never block the safety valve or drain line. This can cause a dangerous overpressure in the storage tank.

CAUTION

When heating water, slight, temporary discharge from the safety valve can occur. This is a correct safety valve function. Any attempt to interfere in its operation can lead to the danger and destruction of the storage tank.

CAUTION

Never use the equipment with clogged safety valves.

Connection

After the installation and levelling the tank, follow the procedure below (for the connector pipe symbols, refer to page 17):

1. Remove protecting plugs from the connector pipes
2. Connect the hot water intake line (N).
3. Connect the cold water supply line together with the required safety valves (G).
4. If the system has the hot water circulation system, connect it to the connector pipe (L). Otherwise, plug the pipe.
5. Connect the supply (J) and return (H) of the heating medium to the coil.

CAUTION

If there is an electric heating module installed in the storage tank, fill the tank with water before connecting it to the electrical installation.

Hot water circulation circuit

Hot water circulation function is available for PT300/500.

PT300/500

If the system has the hot water circulation system, connect it to the port L (see page 17).

Then install the Cut-off valves, circulation pump and strainer.

Connection of external heat source

External heat source, e.g. a gas or oil boiler or electric heater, can be connected on supply line of heating system (XL1).

Refrigerant circuit

Connecting refrigerant pipes

See Installation manual for outdoor unit.

Piping insulation

Install insulation on all piping in order to avoid condensation during cooling operation.

It is also strongly recommended to insulate piping for heating only application in order to avoid getting burned or reducing the heating capacity.

The thickness of the insulation should be 20mm where the relative humidity exceeds 70%.

Dockings

General

Installation requirements

Hydrolution can be connected in several different ways, some of which are shown on the following pages.

	HSB60-W	HSB100-W
	FDCW60VNX-W	FDCW71VNX-W
Max pressure, climate system	0.25 MPa (2.5 Bar)	0.25 MPa (2.5 Bar)
Highest recommended supply/return temperature	55/45°C	55/45°C
Max temperature, climate system	65 °C	65 °C
Max temperature in indoor unit	65 °C	65 °C
Max temperature from external heat source	65 °C	65 °C
Max supply temperature with compressor at outdoor temp -20°C	58 °C	60 °C
Min supply temp. cooling	7 °C	7 °C
Max supply temp. cooling	25 °C	25 °C
Min volume, climate system during heating, cooling	50 L	50 L
Min volume, climate system during underfloor cooling	80 L	80 L
Max flow, climate system	0.29 L/s	0.38 L/s
Min flow, climate system, at 100% circulation pump speed	0.19 L/s	0.19 L/s
Nominal system flow heating ($\Delta T=5K$)	0.29 L/s (6kW, 7/45°C)	0.38 L/s (8kW, 7/45°C)
Nominal system flow cooling ($\Delta T=5K$)	0.29 L/s (6kW, 35/7°C)	0.34 L/s (7.1kW, 35/7°C)

External circulation pump must be used when the pressure drop in the system is greater than the available external pressure. In such cases, a bypass line with non-return valve must be installed.

Use an overflow valve if system flow cannot be guaranteed.

Symbol key

Symbol	Meaning
	Venting valve
	Shut-off valve
	Non-return valve
	Control valve
	Safety valve
	Temperature sensor
	Expansion vessel
	Pressure gauge
	Circulation pump
	Shunt / shuttle valve
	Fan

Docking alternatives

Heating system can be constructed in several different ways combining indoor unit, tank, control unit and other accessories.

In the system example shown on the following page, heating, hot water as well as cooling operation are available.

Additional heating is helpful on the cold day of the year as the energy from the air is reduced. It is also recommended as back-up in case the heat pump operation is blocked for any reason (e.g. ambient temperature exceeds the operation limit of heat pump).

NOTE

The heating medium side and the hot water side must be fitted with the necessary safety equipment in accordance with the applicable regulations.

This is the outline diagram. Actual installations must be planned according to applicable standards.

Explanation

AA25

Controller

BT1	Outdoor sensor ¹⁾
BT6	Temperature sensor, hotwater charging ¹⁾
BT7	Temperature sensor, hot water top ¹⁾
BT25	Temperature sensor, external supply line ¹⁾
BT50	Room sensor
BT63	Temperature sensor, external supply line after electric heater
BT71	Temperature sensor, external return line ¹⁾
GP10	Circulation pump, Heating medium
QN10	Reversing valve, Hot water/Heating medium ²⁾

EB1

Additional heat

EB1	Immersion heater
KA1	Auxiliary relay/Contactor ²⁾

EB101

Heat pump system

BP4	Pressure sensor, condenser ³⁾
BT3	Temperature sensor, return line ³⁾
BT12	Temperature sensor, condenser supply line ³⁾
BT15	Temperature sensor, fluid pipe ³⁾
EB101	Heat pump
FL10	Safety valve
GP12	Charge pump ²⁾
HQ1	Particle filter ³⁾
QM1	Drain valve, Heating medium
QM31	Shut-off valve, Heating medium, Flow
QM32	Shut off valve, Heating medium, Return
QM43	Shut-off valve

EQ1

Cooling system

BT64	Temperature sensor, cooling supply line ²⁾
CP6	Single jacket accumulator tank, cooling
GP13	Circulation pump, cooling
QN12	Reversing valve, Cooling/Heating ²⁾

Miscellaneous

CM1	Expansion vessel closed, Heating medium
CP5	Buffer vessel
CP10	Accumulator tank with hotwater heating
EB20	Immersion heater
FL2	Safety valve, Heating medium
KA1	Auxiliary relay/Contactor
RN10	Trim valve

1) Included in and supplied with controller

2) Included in and supplied with accessory

3) Included in indoor unit

Installation with indoor unit HSB60/100-W, tank PT300/500, controller RC-HY20/40-W with step controlled additional heat before reversing valve for hot water and cooling function (4 pipe system)

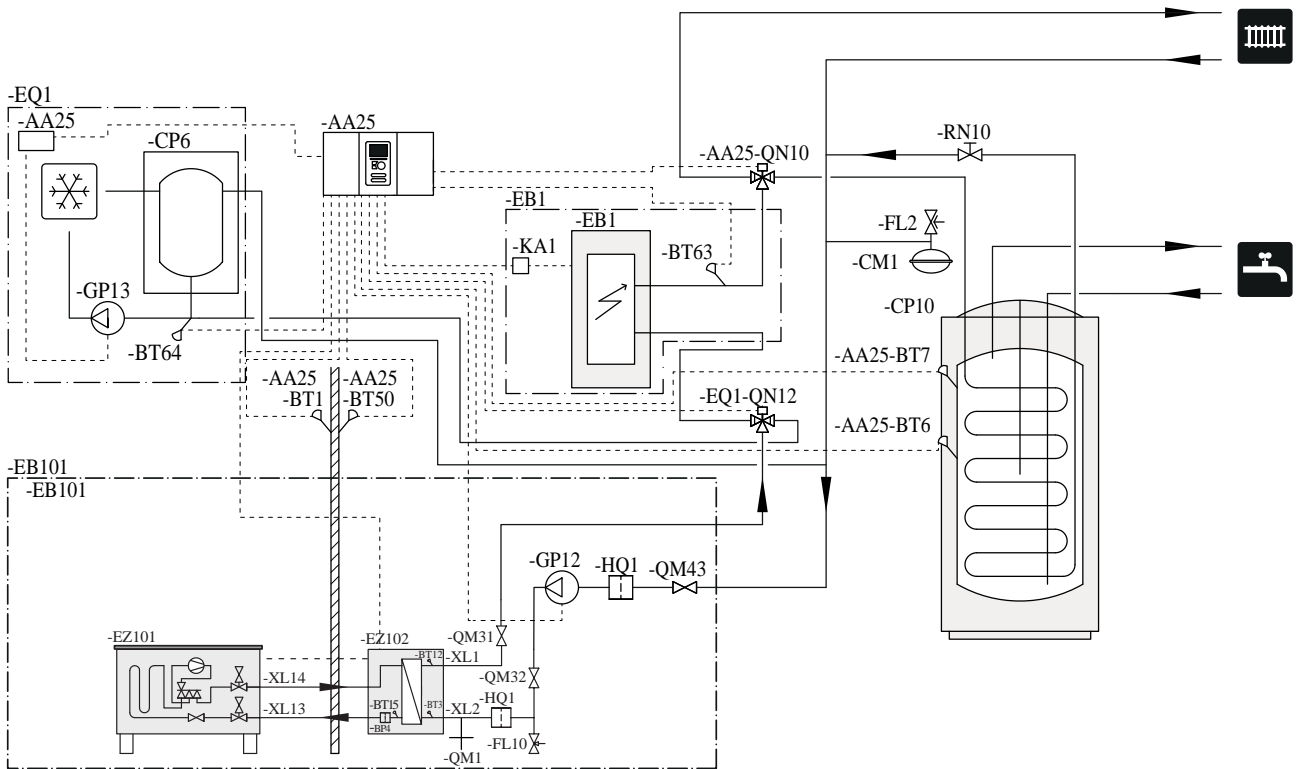

NOTE

Not all components are shown in this outline diagram.

Controller (AA25) starts and stops the heat pump (EB101) to meet the heating and hot water demand.

At simultaneous heating and hot water demand, the reversing valve (AA25-QN10) switches periodically between the climate system and the water heater/accumulator tank (CP10). When the hot water heater/accumulator tank is fully charged, the reversing valve switches to the climate system.

Additional heat (EB1) is turned on automatically when the heating demand exceeds the heat pump capacity. This is used for both heating and charging hot water.

The additional heat can also be used for water heater when a higher temperature is required than the heat pump can produce.

During cooling operation, the reversing valve (EQ1-QN12) switches to the cooling system (EQ1). If several simultaneous demands occur while there is a cooling demand, the system reacts differently. In the event of a hot water demand, the reversing valve switches back and hot water is produced until the demand is fulfilled. In the event of a heating demand, the reversing valve switches periodically between cooling and heating. If the cooling demand is met, the reversing valve switches back to basic mode (heating/hot water).

Indoor unit HSB60/100-W, tank PT300/500, controller RC-HY20/40-W with step controlled additional heat after reversing valve for hot water and cooling function (4 pipe system)

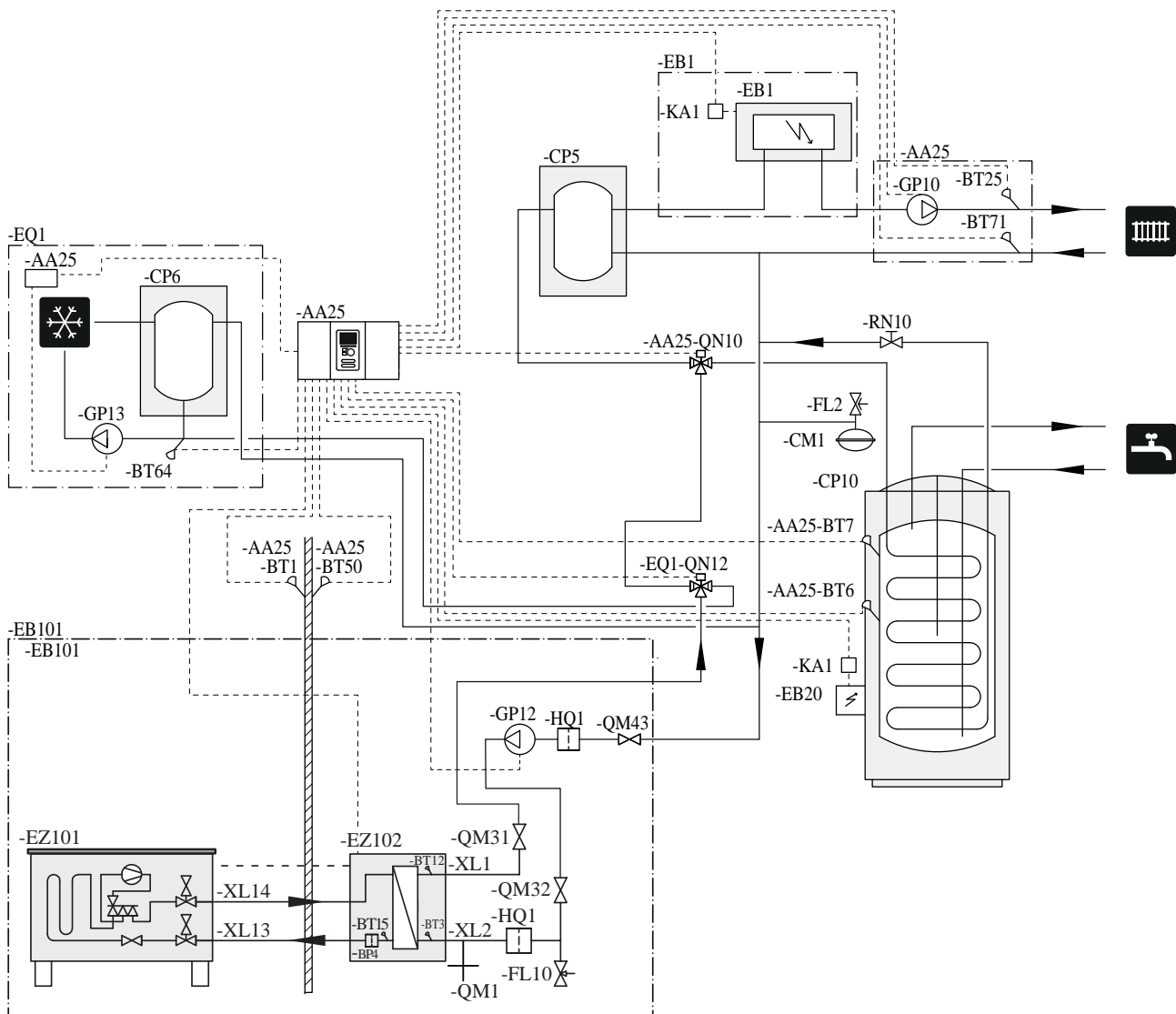

NOTE

Not all components are shown in this outline diagram.

This installation alternative is suitable for more complex installations with a focus on comfort.

Controller (AA25) starts and stops the heat pump (EB101) to meet the heating and hot water demand of the installation.

At simultaneous heating and hot water demand the reversing valve (AA25-QN10) switches periodically between the climate system and the water heater/accumulator tank (CP10). When the hot water heater/accumulator tank is fully charged, the reversing valve switches to the climate system.

Additional heat (EB1) is turned on, automatically when the heating demand exceeds the heat pump capacity.

Immersion heater (EB20) in the water heater/accumulator tank is used during the time to produce hot water if the heat pump is used for heating at the same time.

The immersion heater (EB20) can also be used if a higher temperature of hot water is required than the heat pump can produce.

During cooling operation, the reversing valve (EQ1-QN12) switches to the cooling system (EQ1). If several simultaneous demands occur while there is a cooling demand, the system reacts differently. In the event of a hot water demand, the reversing valve switches back and hot water is produced until the demand is fulfilled. In the event of a heating demand, the reversing valve switches periodically between cooling and heating. If the cooling demand is met, the reversing valve switches back to basic mode (heating/hot water).

Electrical installation

General

Indoor unit must be installed via an isolator switch in accordance with the local codes and regulations.

- Disconnect the indoor unit, outdoor unit and control unit before insulation testing of the house wiring.
- If the building is equipped with an earth-fault breaker, Hydrolution should be equipped with a separate one.
- For the electrical wiring diagram, see page 91-101.
- Do not lay communication, sensor or signal cables for external connection close to high voltage lines.
- Minimum cross section of communication, sensor or signal cables for external connection must be 0.5mm² up to 50 m, for example EKKX, LiYY or equivalent.
- Use screened three core cable for communication between controller (RC-HY20/40-W) and indoor unit (HSB60/100-W).
- When laying cables into indoor units and controllers, be sure to route the cable grommet (UB1 AND UB2).
- Be careful to route cables not to be damaged by metal edge or trapped by panels.

NOTE

Electrical installation and service must be carried out under the supervision of a qualified electrician.

Turn off the circuit breaker before carrying out any servicing.

Electrical installation and wiring must be carried out in accordance with the stipulations in force.

Make sure to turn off the power supply during installation.

NOTE

Do not turn on the power on control until the boiler is filled with water.

The circulation pump and immersion heater may become damaged.

NOTE

If the power supply cable is damaged, only authorised person may replace it to avoid danger or damage.

Principle diagram, electrical installation

HSB60/100-W

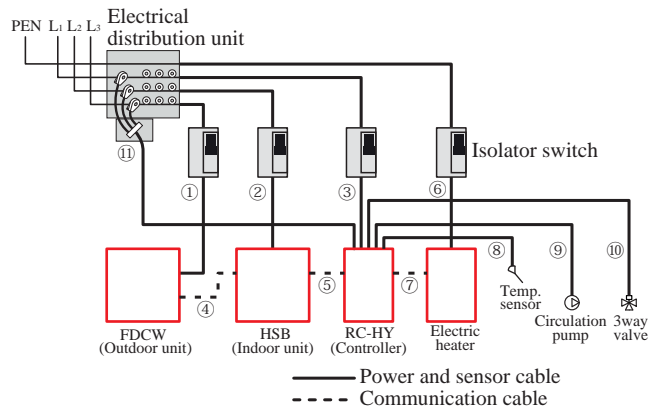

Item		Cable size
①	Power - FDCW60VNX-W	3core, 2.0mm ² (power cable)
	Power - FDCW71VNX-W	3core, 3.5mm ² (power cable)
②	Power - HSB60-W	3core, 1.5mm ² (power cable)
	Power - HSB100-W	
③	Power - Controller	3core, 1.5mm ² (power cable)
④	Outdoor unit - Indoor unit	2core, 1.5mm ² (communication cable)
⑤	Indoor unit - Controller	3core, 0.5mm ² , LiYY,EKKX or equivalent (communication cable)
⑥	Power - Electrical heater	Selected according to power source voltage (230V/400V). Please refer to installation manual for ELK
⑦	Controller - Electrical heater	4core, 0.5mm ² (communication cable)
⑧	Controller - Temp sensors	2core, 0.5mm ² (each sensor)
⑨	Controller - Circulation pump	3core, 0.75mm ² (power cable)
		2core, 0.5mm ² (communication cable)
⑩	Controller - 3way valve for switching heating/hot water	3core, 0.75mm ²
⑪	Current sensor (RC-HY40-W only)	6core, 0.5mm ²

The cable size shown on the above table is minimum size. Choose appropriate size according to local laws and regulations.

NOTE

When laying cables into the indoor unit and controllers, be sure that the cables are groomed to avoid excessive resistance to the terminal blocks.

If there is an excessive resistance applied to the wiring, they may disconnect and damage the unit (short circuit)

Electrical components

HSB60/100-W

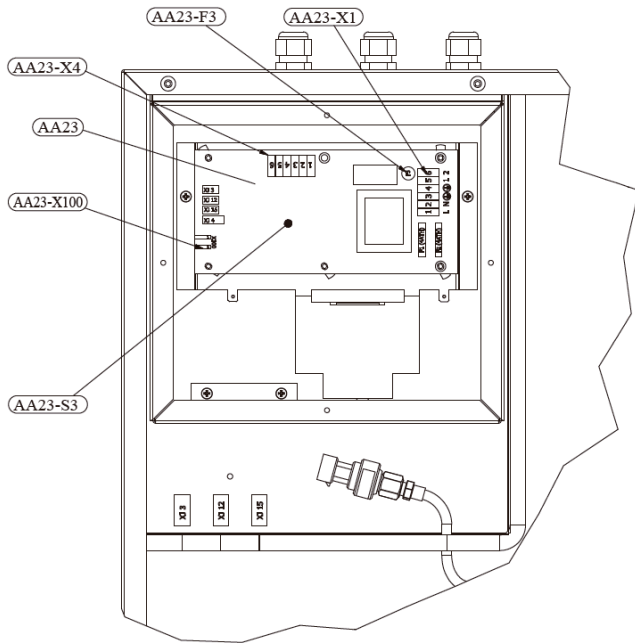

Explanation

AA23	Communication board
AA23-F3	Fuse for external heating cable
AA23-S3	DIP switch, addressing of outdoor unit
AA23-X1	Terminal block, incoming supply, connection of KVR
AA23-X4	Terminal block, communication with indoor module / control module
AA23-X100	Terminal block, communication outdoor module FDCW

RC-HY20-W

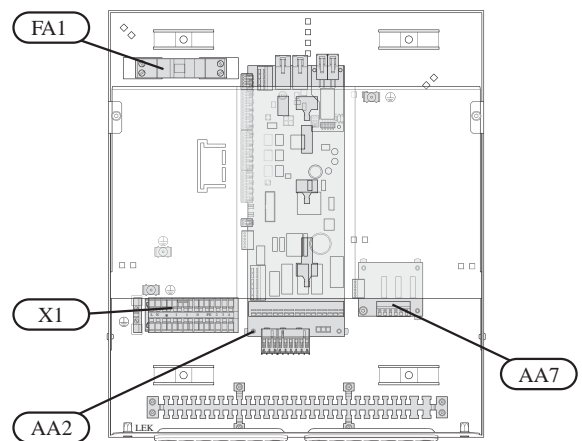
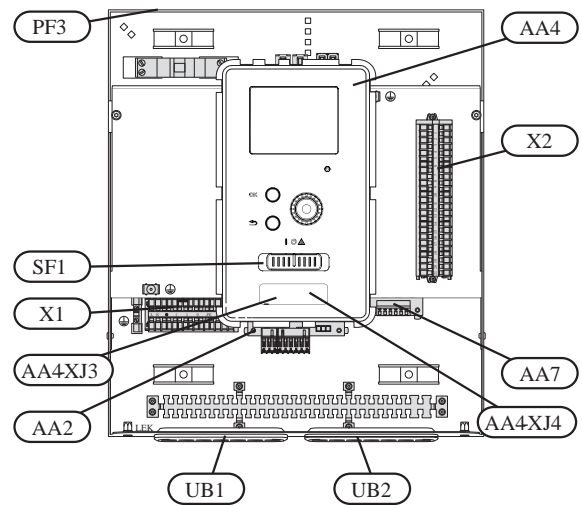

Explanation

AA2	Base card
AA4	Display unit
AA4-XJ3	USB socket
AA4-XJ4	Service outlet (No function)
AA7	Extra relay circuit board
FA1	Miniature circuit-breaker
X1	Terminal block, incoming electrical supply
X2	Terminal block, control signal circulation pump, sensors AUX inputs and heat pump
SF1	Switch
PF3	Serial number plate
UB1	Cable grommet, incoming supply electricity, power for accessories
UB2	Cable grommet, signal

RC-HY40-W

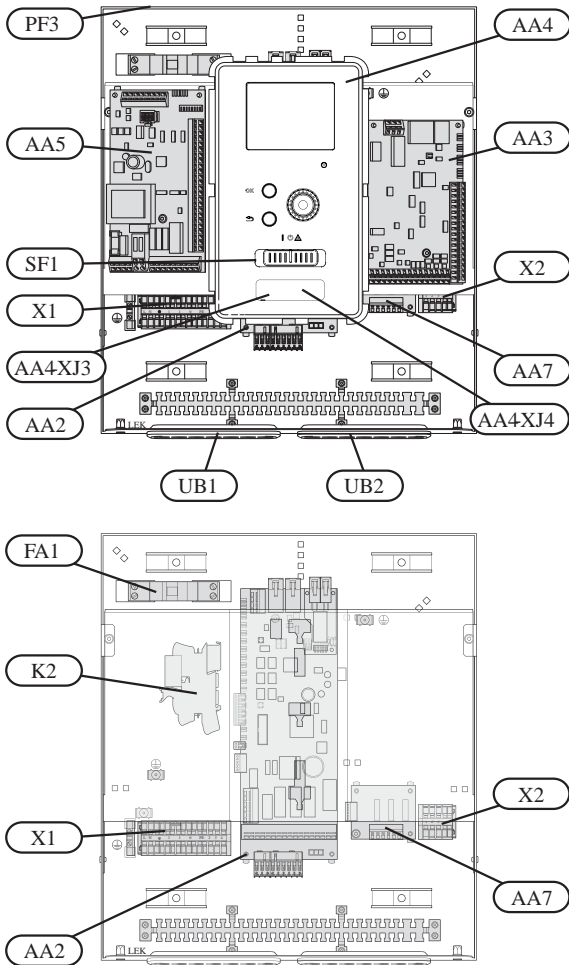

Explanation

- AA2 Base card
- AA3 Input circuit board
- AA4 Display unit
- AA4-XJ3 USB socket
- AA4-XJ4 Service outlet (No function)
- AA5 Accessory card
- AA7 Extra relay circuit board
- FA1 Miniature circuit-breaker
- K2 Emergency mode relay
- X1 Terminal block, incoming electrical supply
- X2 Terminal block, AUX4 - AUX6
- SF1 Switch
- PF3 Serial number plate
- UB1 Cable grommet, incoming supply electricity, power for accessories
- UB2 Cable grommet, signal

Accessibility, electrical connection for controller

The cover of the control module is opened using a Torx 25 screwdriver. Assembly takes place in the reverse order.

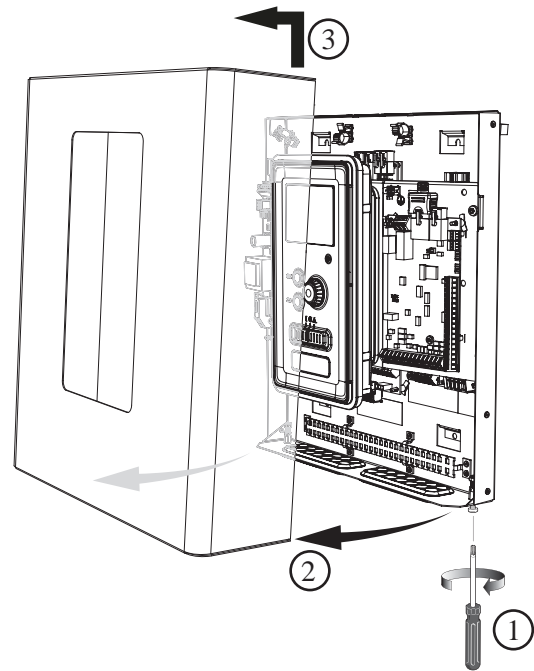

NOTE

The cover to access the base board is opened using a Torx 25 screwdriver

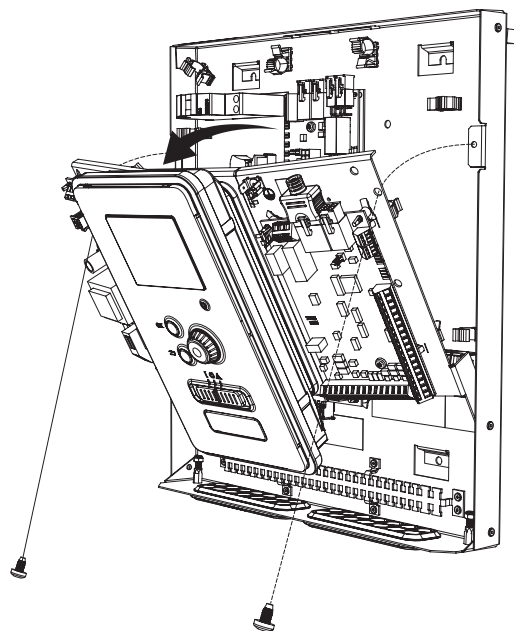

The display may need to be moved for easier access when connecting electrics. This is easily done by following these steps.

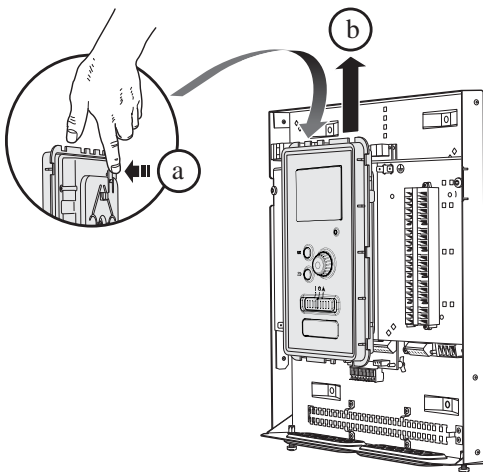

1. Press in the catch on the upper rear side of the display unit towards you (a) and move the display unit upwards (b) so that the mountings unhook from the panel.

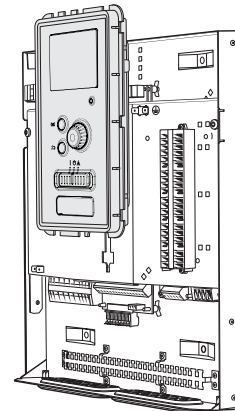

4. Secure the display on the panel.
5. When the electrical connection is ready the display must be reinstalled with three mounting points again, otherwise the front cover cannot be installed.

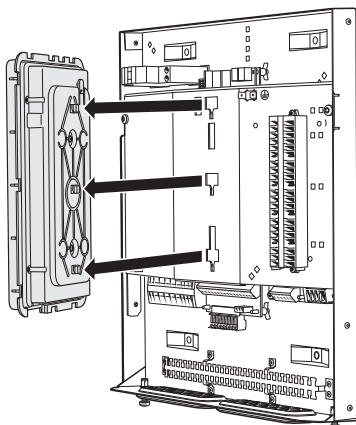

2. Lift the display unit from its mountings.

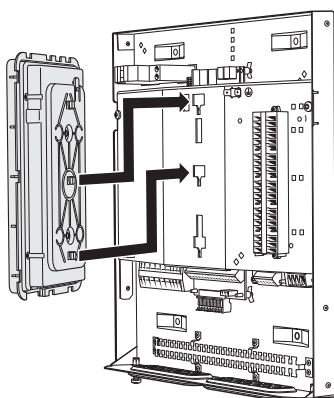

3. Align the two lower mountings on the reverse of the display unit with the two upper holes in the panel as illustrated.

Cable lock

Use a suitable tool to release/lock cables in the terminal block.

HSB60/100-W, RC-HY20/40-W

Terminal block on the electrical card

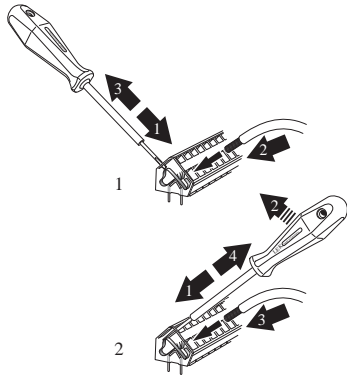

Terminal block

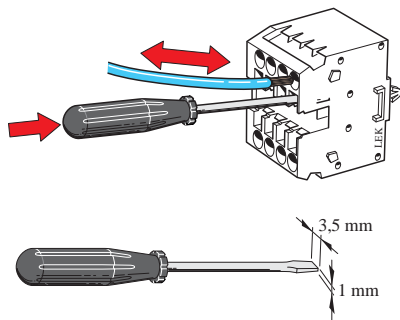

Connection for HSB60/100-W

NOTE

To prevent interference, unscreened communication and/or sensor cables to external connections must not be laid closer than 20 cm from high voltage cables.

Power supply

Indoor unit

In case of HSB60/100-W, power supply is made to indoor unit, outdoor unit and controller separately. 230V 1AC 50Hz is applied.

For indoor unit, incoming supply is connected on AA23-X1 terminal.

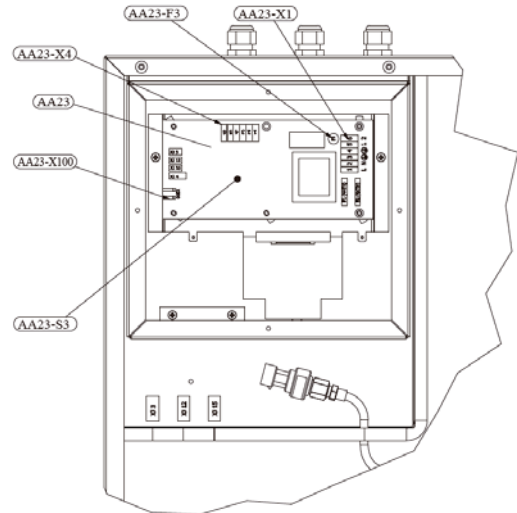

For outdoor unit, incoming supply is connected on TB terminal. See figure on Connection between indoor and outdoor unit.

Connection between indoor and outdoor unit

The communication cable between indoor and outdoor unit is connected between terminal AA23-X100 in indoor unit and TB in outdoor unit. Screened 2 core cable is recommended.

<HSB60-W with FDCW60VNX-W>

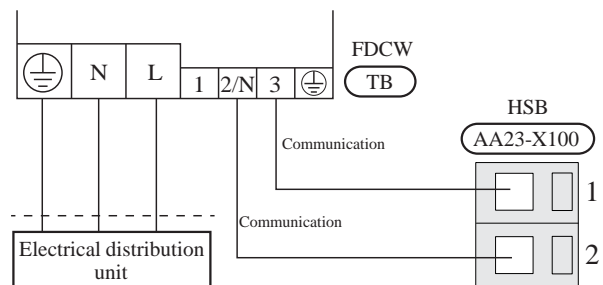

<HSB100-W with FDCW71VNX-W>

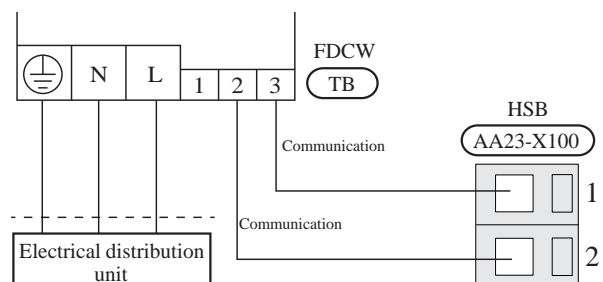

Connection between indoor unit and controller

See Connection for RC-HY20/40-W

Cascade connection setting

In case of cascade connection system, it is necessary to allot unique address to each indoor unit. Set the dip switch S3-1, -2 and -3 according to the following table.

Address	S3:1	S3:2	S3:3
1	OFF	OFF	OFF
2	On	OFF	OFF
3	OFF	On	OFF
4	On	On	OFF
5	OFF	OFF	On
6	On	OFF	On
7	OFF	On	On
8	On	On	On

Recommended fuse size

The recommended fuse size shown in the following table is reference value. Choose appropriate size according to local laws and regulations.

	Recommended fuse size
HSB60-W	6A/230V 1AC 50Hz
HSB100-W	6A/230V 1AC 50Hz
FDCW60VNX-W	20A/230V 1AC 50Hz
FDCW71VNX-W	20A/230V 1AC 50Hz
RC-HY20/40-W	10A/230V 1AC 50Hz
Electric heater (ELK9M/9M1)	16A/400V 3NAC 50Hz 9kW
	40A/230V 1AC 50Hz 9kW
	20A/230V 1AC 50Hz 4.5kW

Recommended cable size

The recommended cable size shown in the page 26 is reference value. Choose appropriate size according to local laws and regulations.

RC-HY20/40-W

Cable connection is different according to the system structure. Refer to the connection method according to the indoor unit

Power source

Connect the power cable on X1 terminal as shown below.

RC-HY20/40-W must be installed via an isolator switch with a minimum breaking capacity of 3mm. Minimum cable area must be sized according to the fuse rating used.

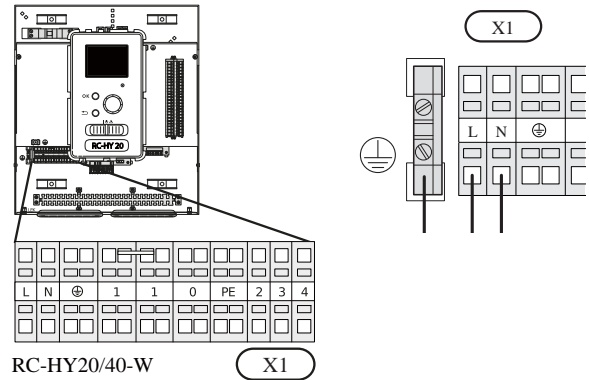

RC-HY20-W

Connection between controller and indoor unit

HSB60/100-W

Signal cable is connected between the controller and the indoor unit with screened 3 cores cable for HSB series.

Connect the port 19 (A), 20 (B) and 21 (GND) on X2 terminal on RC-HY20-W on the port 1,2 and 3 on X4 terminal on AA23 board respectively

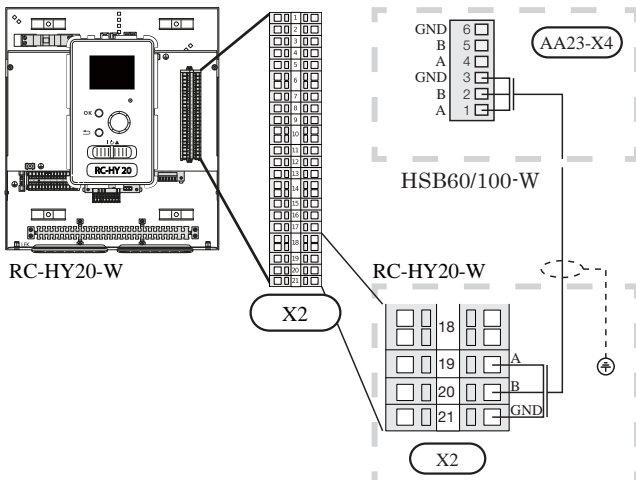

Connection between controller and circulation pump (GP12)

For HSB60/100-W, circulation pump (GP12) is installed outside of indoor unit. Choose correct terminal according to the type of controller.

Connect the port 5, 6 and 7 on X4 terminal on AA2 board on RC-HY20-W to the port PE, N and L on circulation pump respectively. Control signal cable is connected between the port 1 and 2 on X2 terminal on RC-HY20-W and PWM and GND on circulation pump respectively as shown below.

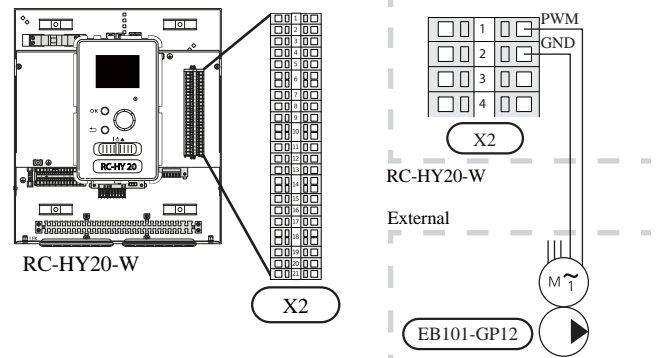
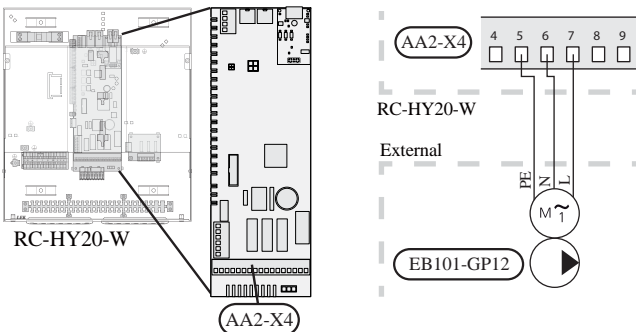

Connection between controller and 3-way valve (QN10/QN12)

3-way valve is used for switching heating / hot water production (QN10), or switching heating / cooling (QN12). Install appropriate valves according to the system structure on site.

HSB60-W is not equipped with 3-way valve. Install the valves on right position according to the diagram and connect wires on appropriate port according to the type of controller.

• **3-way valve for Heating / Hot water (QN10)**

Connect the N, Control and L wire on 3-way valve to the port 2, 3 and 4 on X4 terminal on AA2 board on RC-HY20-W respectively as shown below.

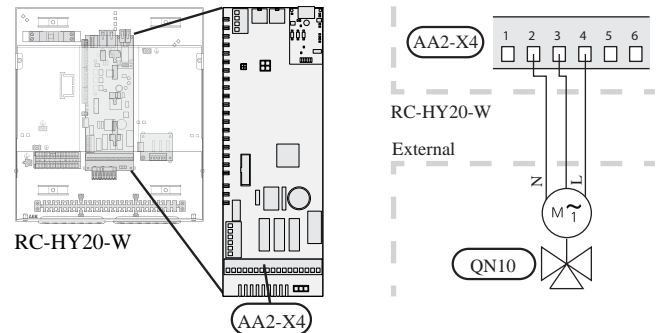

• **3-way valve for Heating / Cooling (QN12)**

QN12 can be controlled with potential free variable relay. Connect L and Control wire on 3-way valve to the port 15 and 16 on X4 terminal on AA2 board on RC-HY20-W respectively. Also, connect L and N wire to power supply as shown below.

Additional setting is necessary in menu 5.4. See Menu system for details.

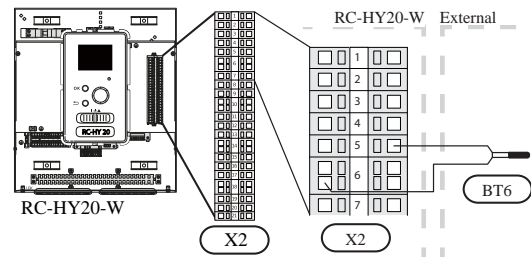
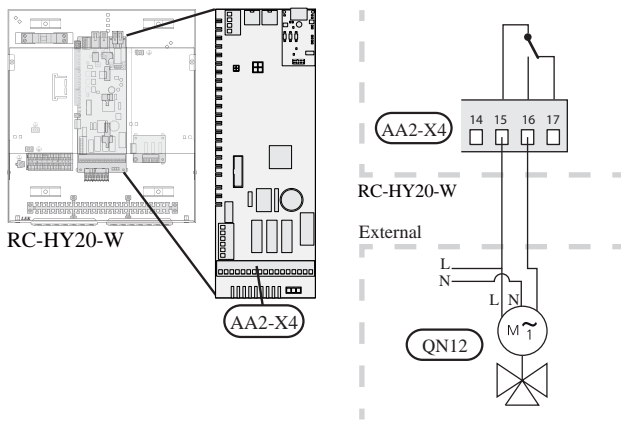

• **Hot water sensor BT7 (tank top)**

A temperature sensor for hot water top (BT7) can be connected to RC-HY20 to show the water temperature at the top of the tank (if it is possible to install a sensor at the top of the tank).

Connect the sensor to the port 4 and 6 on X2 terminal.

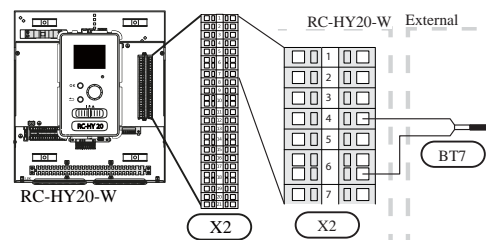

• **Temperature sensor BT63, outlet at additional heater**

This sensor is used in case electric heater is placed before 3-way valve (QN10) for switching heating/hot water (see page 24 for diagram).

Connect temperature sensor, external supply after electric heater (BT63) to the port 9 and 10 on terminal X2.

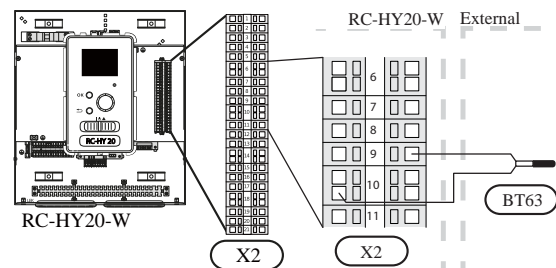

• **Temperature sensor BT25, outlet for heating**

This sensor is used in case electric heater is placed after 3 way valve (QN10) for switching heating/ hot water (see page 25 for diagram).

Connect temperature sensor, external supply (BT25) to the port 8 and 10 on X2 terminal.

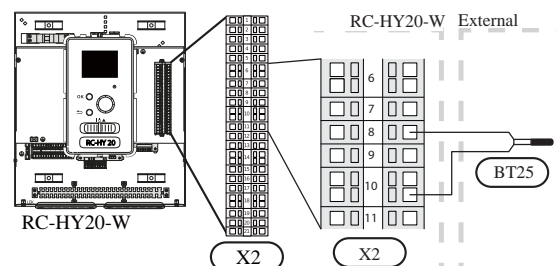

CAUTION

The relay outputs can have a max load of 2 A at resistive load (230V AC).

Connection between controller and sensors

Sensor connection is different according to the combination of indoor unit and controller. Refer to the appropriate combination mentioned below.

Use two-core cable with a minimum 0.5mm² cross section.

Regarding other sensors not mentioned in this chapter, refer to page 34, Optional connections.

• **Ambient air temperature sensor BT1**

Install ambient air temperature sensor (BT1) in the shade on a wall facing north or north-west, so it is unaffected by the morning sun.

Connect the sensor to the port 3 and 6 on X2 terminal.

If a conduit is used it must be sealed to prevent condensation in the sensor capsule.

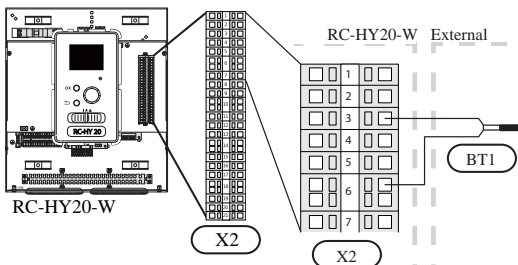

• **Hot water charging sensor BT6 (tank bottom)**

The temperature sensor, hot water charging (BT6) is placed in the submerged tube on the water heater.

Connect the sensor to the port 5 and 6 on X2 terminal.

Hot water charging is activated in menu 5.2 or in the start guide.

- **Temperature sensor BT71, return line for heating**

This sensor is used in case electric heater is placed after 3 way valve (QN10) for switching heating/ hot water (see page 25 for diagram).

For connection, see page 36, AUX inputs.

- **Temperature sensor BT64, outlet for cooling**

This sensor is used in case cooling application is required.

For connection, see page 36, AUX inputs.

Optional connections

- **Room sensor BT50**

Room sensor can be connected to controller.

The room temperature sensor has up to three functions:

1. Show current room temperature in the control module display.
2. Option of changing the room temperature in °C.
3. Makes it possible to change/stabilise the room temperature.

Install the sensor in a neutral position where the set temperature is required. A suitable location is on a free inner wall in a hall approx. 1.5 m above the floor.

Do not install the sensor where correct room temperature cannot be detected such as in a recess, between shelves, behind a curtain, above or close to a heat source, in a draft from an external door or in direct sunlight.

Closed radiator thermostats can also cause problems.

The control module can operate without the sensor, but if user wants to read off the accommodation's indoor temperature in controller display, the sensor must be installed.

Connect the room sensor to the port 7 and 10 on X2 terminal.

If the sensor is to be used to change the room temperature in °C and/or to change/stabilise the room temperature, the sensor must be activated in menu 1.9.4.

If the room sensor is used in a room with underfloor heating, it should only have an indicative function, not control of the room temperature.

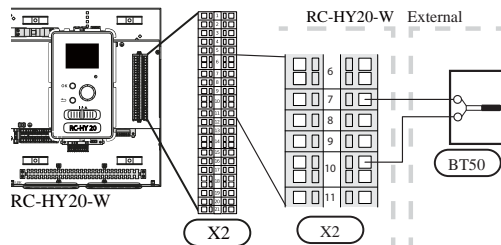

CAUTION

Changes of temperature in accommodation take time. For example, short time periods in combination with underfloor heating will not give a noticeable difference in room temperature.

Use two-core cable with a minimum 0.5mm² cross section.

• Step controlled additional heat

NOTE

Mark up any junction boxes with warnings for external voltage.

External step controlled additional heat can be controlled by up to three potential-free relays in the control module (3 step linear or 7 step binary). Alternatively two relays (2 step linear or 3 step binary) can be used for step controlled additional heat, which means that the third relay can be used to control the immersion heater in the water heater/accumulator tank.

Step in occurs with at least 1 minute intervals and step outs with at least 3 seconds intervals.

Step 1 is connected to terminal block X2:2 on the additional relay board (AA7).

Step 2 is connected to terminal block X2:4 on the additional relay board (AA7).

Step 3 or immersion heater in the water heater/accumulator tank is connected to terminal block X2:6 on the additional relay board (AA7).

The settings for step controlled additional heat are made in menu 4.9.3 and menu 5.1.12.

All additional heat can be blocked by connecting a potential-free switch function to the software controlled input on terminal block X2 which is selected in menu 5.4.

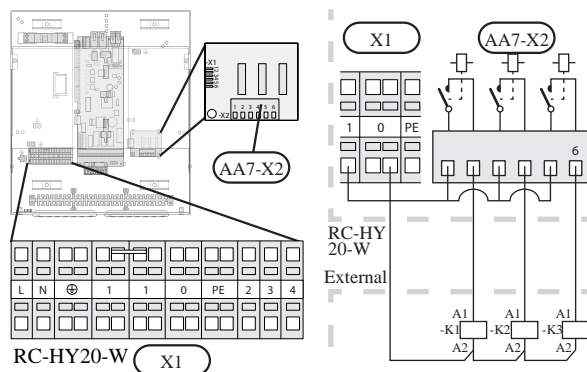

If the relays are to be used for control voltage, bridge the supply from terminal block X1:1 to X2:1, X2:3 and X2:5 on additional relay board (AA7). Connect the neutral from the external additional heat to terminal block X1:0.

Use a cable with appropriate cross section.

For connection, see the installation manual for additional heater.

• Relay output for emergency mode

NOTE

Mark up any junction boxes with warnings for external voltage.

When the switch (SF1) is in "Δ" mode (emergency mode) the circulation pump is activated (EB101-GP12).

CAUTION

No hot water is produced when emergency mode is activated.

The emergency mode relay can be used to activate external additional heat. Between the port 2 and 4 is closed during emergency mode. An external thermostat must be connected to the control circuit (port 4) to control the temperature. Ensure that the heating medium circulates through the external additional heating.

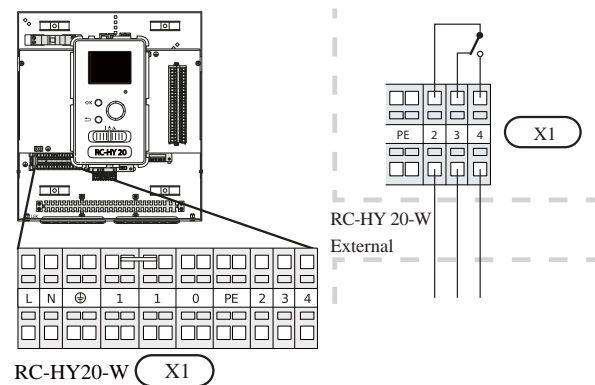

If the relay is to be used for control voltage, bridge the supply from terminal block X1:1 to X1:2 and connect neutral and control voltage from the external additional heat to X1:0 (N) and X1:4 (L).

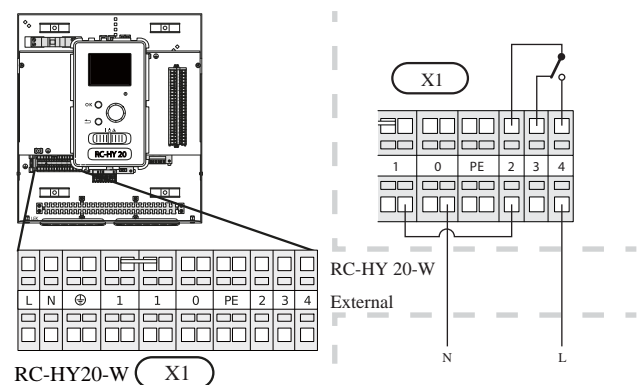

• External circulation pump

Connect the external circulation pump (GP10) to terminal block X4:9 (PE), X4:10 (N) and X4:11 (230 V) on the base board (AA2) as illustrated.

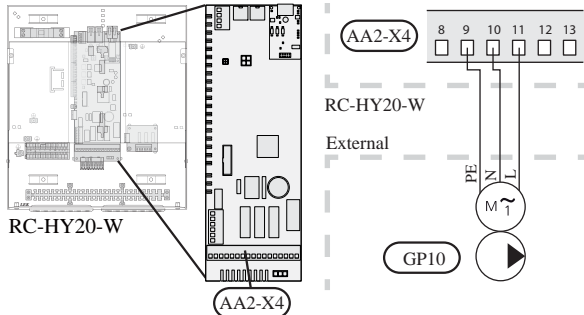

• AUX inputs

Other external inputs are available on the port 11 through 18 on X2 terminal on RC-HY20-W.

AUX1, 2, 3, 4, 5, and 6 correspond to the port 11, 12, 13, 15, 16 and 17 respectively. Port 14 and 18 are GND and are common to the all auxiliary circuit. Connect a sensor or switch between AUX and GND with a two-core cable with a minimum cross section of 0.5mm².

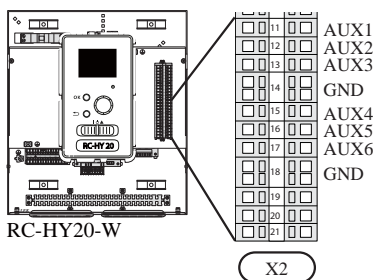

Select the appropriate function in menu 5.4.

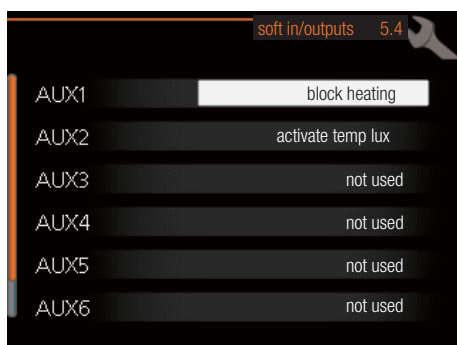

■ Temperature sensor, cooling/heating (BT74)

Additional room sensor (BT74) is applied in case user wants to determine the operation mode (cooling/heating) with a temperature in a particular room.

This option can be chosen only in case cooling function is available.

■ Temperature sensor, external return line (BT71)

Temperature sensor BT71 is applied in case additional heater is placed after 3-way valve (see page 25 for diagram).

■ Temperature sensor, flow line cooling (BT64)

Temperature sensor BT64 is required in case 4-pipe system is used for cooling operation. (see page 24, 25 for diagram)

This option can be chosen only in case cooling function is activated.

■ Contact for external tariff blocking

In cases where external tariff blocking is required it must be connected to terminal block X2.

Tariff blocking means that the additional heat, the compressor, heating and cooling are disconnected by connecting a potential free switch function to the input selected in menu 5.4.

A closed contact results in the electrical output being disconnected.

■ Switch for "SG ready"

NOTE

This function can only be used in mains networks that support the "SG Ready"-standard. "SG Ready" requires two AUX inputs.

This function can only be used in power supply networks that support the "SG Ready" standard. "SG Ready" requires two AUX inputs.

"SG Ready" is a smart tariff management scheme in which electricity supplier can affect indoor and hot water temperature or simply prohibits additional heat and/or the compressor operation in heat pump at certain period of the day. You can choose which operation mode is affected by this function in menu 4.1.5 after the function is activated.

Choose two external input circuits and connect potential-free switches, and set "SG Ready A" and "SG Ready B" in menu 5.4. The system works differently according to the combination of the circuit open/closed.

• Blocking (A: Closed, B: Open)

"SG Ready" is active. Compressor operation and additional heat is prohibited.

• Normal mode (A: Open, B: Open)

"SG Ready" is not active. No effect on the system.

• Low price mode (A: Open, B: Closed)

"SG Ready" is active. The system operates to provide higher capacity than normal mode by using lower tariff electricity. You can select the operation mode (heating/hot water/cooling) affected by this function in menu 4.1.5.

• Overcapacity mode (A: Closed, B: Closed)

"SG Ready" is active. The system supplies higher capacity than Low price mode since the electricity price is supposed to be very low in this mode. You can select the operation mode (heating/hot water/cooling) affected by this function in menu 4.1.5.

■ Contact for activation of “temporary lux”

Temporary hot water production function “temporary lux” is activated with this signal. Connect the terminals with a potential-free switch and choose the function in menu 5.4.

“Temporary lux” is activated only when the switch is closed.

■ Contact for activation of “external adjustment”

Target temperature offset for supply temperature or room temperature can be done with this signal.

When a room sensor is connected and activated, the target room temperature is offset in °C if the switch is closed.

When a room sensor is not connected, target supply water temperature (heat curve) is offset instead. The degree of offset can be set in menu 5.4.

■ Switch for external alarm

Alarms from external devices can be connected to the control and appear as an info alarm. Potential-free signal of NO or NC type can be connected.

■ Switch for external blocking

This function is used in case certain operation mode needs to be prohibited. The operation at selected operation mode is prohibited when the switch is closed. Following functions can be managed.

- Additional heat
- compressor operation
- heating mode
- cooling mode
- hot water mode

• AUX outputs

External output is available on the port 15 to 17 on X4 terminal on AA2 board on RC-HY20-W. The relay output can have a max load of 2A at resistive load.

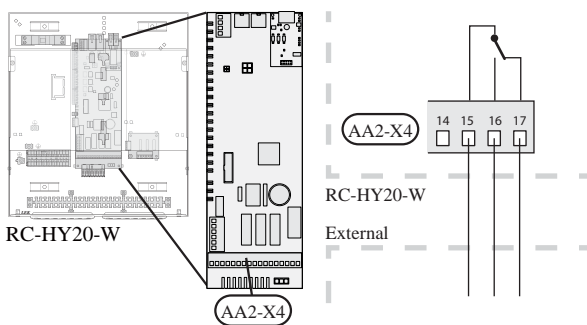

Following functions are available. Select the function in menu 5.4.

• Indication of buzzer alarm

When an alarm occurs, the circuit becomes closed between the port 15 and 16. During normal operation, the port 15 and 17 is closed.

• Cooling mode indication / Active cooling mode (4-pipe cooling)

When the system turns into cooling mode, the circuit

becomes closed between the port 15 and 16. By using this signal, it is possible to switch 3-way valve for 4-pipe cooling or to assemble a display circuit indicating cooling mode. For details of connecting the 3-way valve, refer to page 32.

• External pump control (GP10)

External pump (GP10) is used in case additional heater is placed after 3-way valve that switches heating/hot water (refer to page 25 for diagram).

Connect the circulation pump as shown below using the port 15 and 16 on X4 terminal.

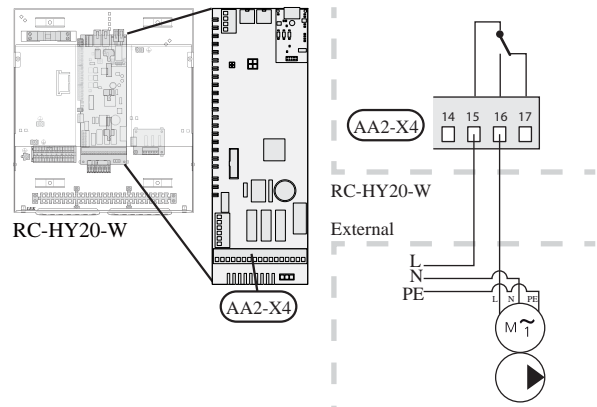

• myUpway™

Connect the network connected cable (straight, Cat.5e UTP) with RJ45-contact (male) to contact AA4-X9 on the display unit (as illustrated). Use the cable grommet (UB2) in the control module for cable routing.

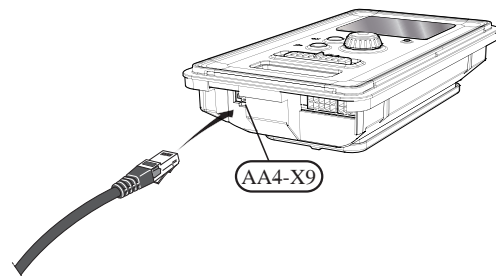

RC-HY40-W

Connection between controller and indoor unit

HSB60/100-W

Connect the port 1(A), 2(B) and 3(GND) on X4 terminal on AA5 board on RC-HY40-W to the port 1, 2 and 3 on X4 terminal on AA23 board on HSB60-W respectively.

In case several systems are connected to one controller, connect the port 4, 5 and 6 on X4 terminal on AA23 board on HSB60/100-W close to the controller to the port 1, 2 and 3 on X4 terminal on AA23 board on another HSB.

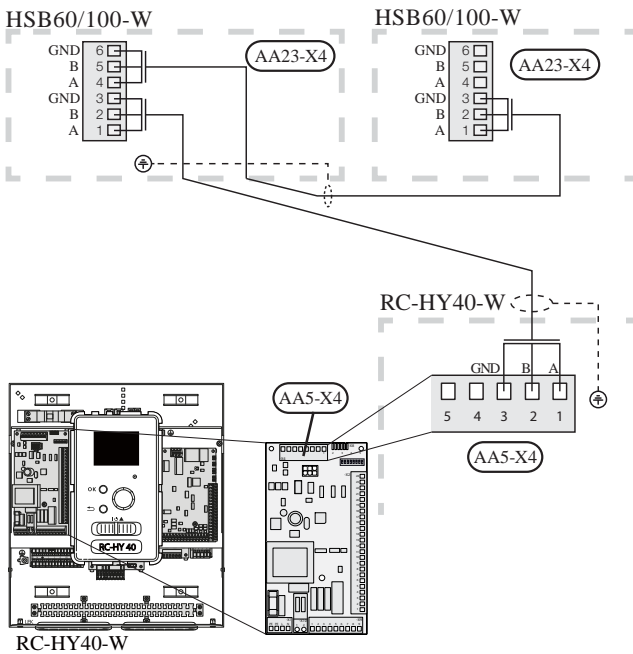

Connection between controller and circulation pump (GP12)

For HSB60/100-W, circulation pump (GP12) is installed outside of indoor unit. Choose correct terminal according to the type of controller.

Connect the port 5, 6 and 7 on X4 terminal on AA2 board on RC-HY40-W to the port PE, N and L on circulation pump (EB101-GP12) respectively. Control signal cable is connected between the port 7 and 8 on X4 terminal on AA3 board on RC-HY40-W and GND and PWM on circulation pump respectively as shown below.

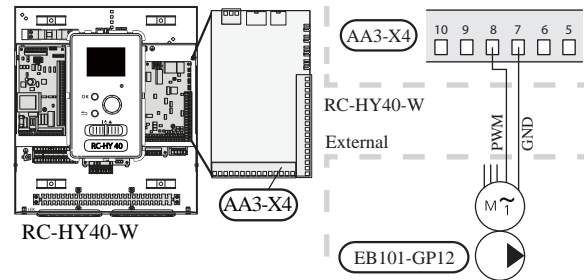
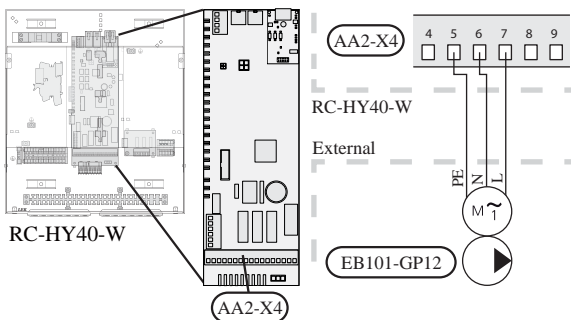

RC-HY40-W can connect and control up to two pumps. Connect the port 12, 13 and 15 on X4 terminal on AA2 board on RC-HY40-W to the port PE, N and L on second circulation pump (EB102-GP12) respectively. Control cable is connected between the port 5 and 6 on X4 terminal on AA3 board on RC-HY40-W and GND and PWM on circulation pump respectively as shown below.

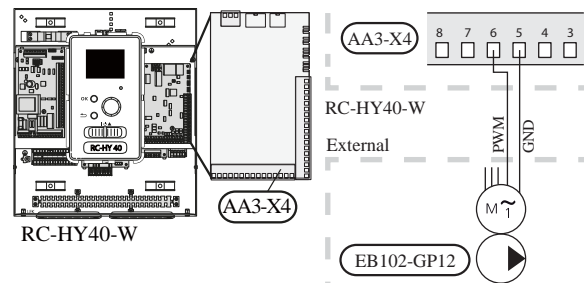
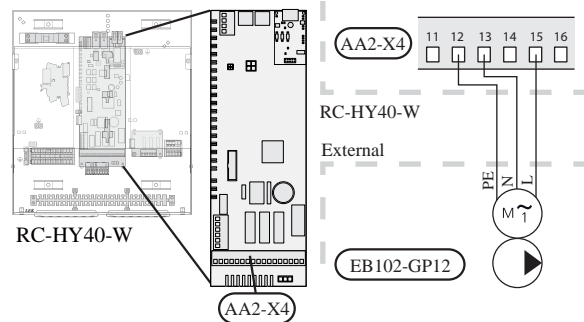

• **3way valve for Heating / Hot water (QN10)**

Refer to 3-way valve connection for HSB60-W with RC-HY20-W (Page 32)

• **3 way valve for Heating / Cooling (QN12)**

QN12 can be controlled with potential free variable relay. Connect L and Control wire on 3-way valve to the port C and NO on X7 terminal on AA3 board on RC-HY40-W respectively. Also, connect L and N wire to power supply as shown below.

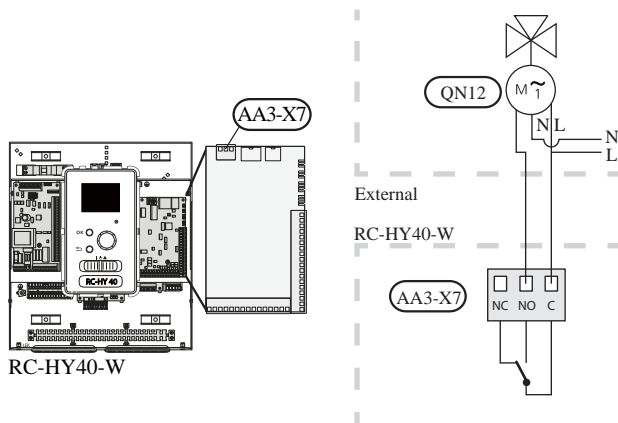

Connection between controller and sensors

Sensor connection is different according to the combination of indoor unit and controller. Refer to the appropriate combination mentioned below.

Use two-core cable with a minimum 0.5mm² cross section.

Regarding other sensors not mentioned in this chapter, refer to page 40, Optional connections.

• **Ambient air temperature sensor BT1**

Install ambient air temperature sensor (BT1) in the shade on a wall facing north or north-west, so it is unaffected by the morning sun for example.

Connect the sensor to the port 1 and 2 on X6 terminal on AA3 board.

If a conduit is used it must be sealed to prevent condensation in the sensor capsule.

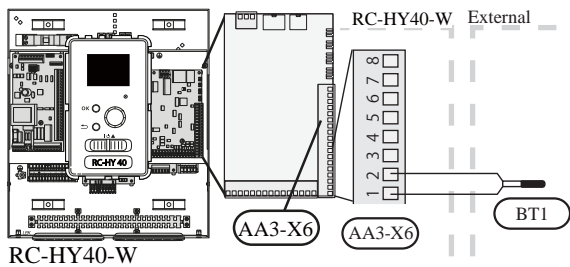

• **Hot water charging sensor BT6 (tank bottom)**

The temperature sensor, hot water charging (BT6) is placed in the submerged tube on the water heater.

Connect the sensor to the port 7 and 8 on X6 terminal on AA3 board.

Hot water charging is activated in menu 5.2 or in the start guide.

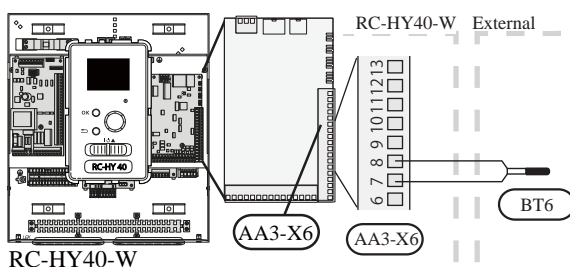

• **Hot water sensor BT7 (tank top)**

A temperature sensor for hot water top (BT7) can be connected to RC-HY40-W to show the water temperature at the top of the tank (if it is possible to install a sensor at the top of the tank).

Connect the sensor to the port 15 and 16 on X6 terminal on AA3 board.

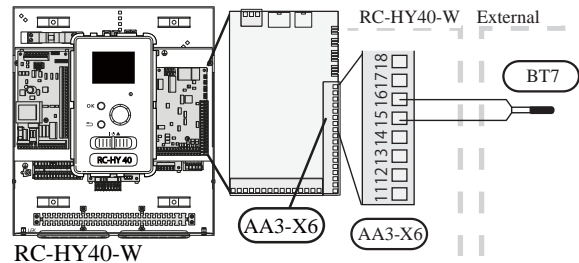

• **Temperature sensor BT63, outlet at additional heater**

This sensor is used in case electric heater is placed before 3 way valve (QN10) for switching heating/ hotwater (see page 24 for diagram).

For connection, see page 41, AUX inputs.

• **Temperature sensor BT25, outlet for heating**

This sensor is used in case electric heater is placed after 3 way valve (QN10) for switching heating/ hot water (see page 25 for diagram).

Connect temperature sensor, external supply line (BT25) to the port 5 and 6 on X6 terminal on AA3 board.

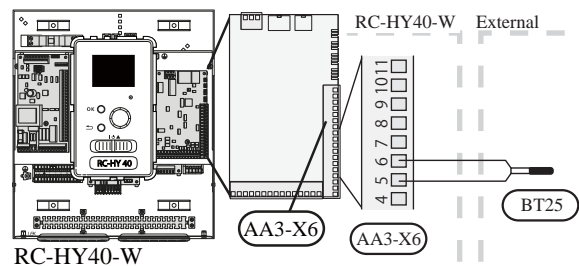

• **Temperature sensor BT71, return line for heating**

This sensor is used in case electric heater is placed after 3 way valve (QN10) for switching heating/ hot water (see page 25 for diagram).

Connect temperature sensor, external return line (BT71) to the port 17 and 18 on X6 terminal on AA3 board.

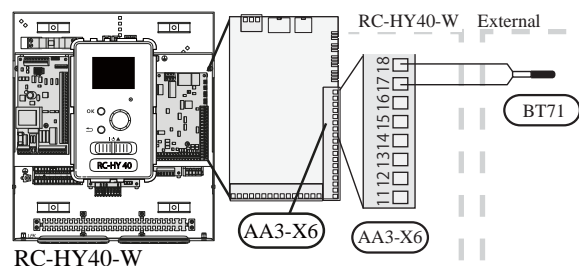

Electrical installation

- **Temperature sensor BT64, outlet for cooling**

This sensor is used in case cooling application is required.

For connection, see page 41, AUX inputs.

Optional connections

- **Load monitor**

In case many power electrical appliances are connected in the property and the electric heater is energised at the same time, there is a risk of tripping the main fuse of the property.

The control module has an integrated load monitor that controls the power steps of the electric heater by disconnecting step by step in the event of overload in a phase. It will be reconnected if other current consumption is reduced.

Connecting current sensors

A current sensor (BE1 - BE3) should be installed on each incoming phase conductor in to the electrical distribution unit to measure the current. This is best done in the electrical distribution unit.

Connect the current sensors to a multi-core cable in an enclosure next to the electrical distribution unit. Use a multi-core cable of at least 0.5 mm² from the enclosure to the heat pump.

Connect the cable to terminal block X4:1 to 4.

X4:1 is the common terminal block for the three current sensors.

Set the size of the property's main fuse in menu 5.1.12.

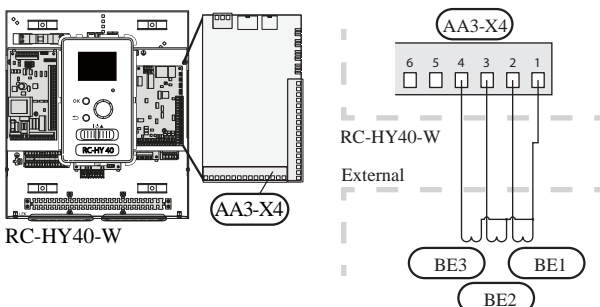
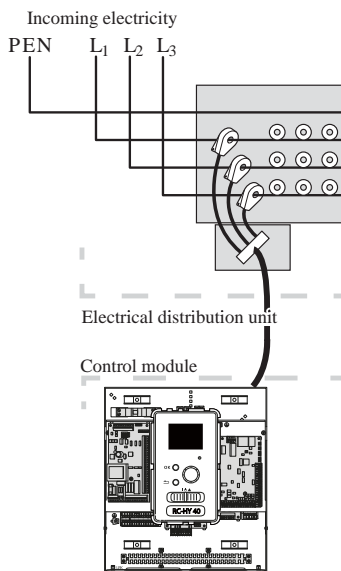

- **Room sensor BT50**

Refer to Room sensor BT50 for RC-HY20-W for function and installation place.

Connect the room sensor to terminal block X6:3 and X6:4 on the input board (AA3).

If the sensor is to be used to change the room temperature in °C and/or to change/stabilise the room temperature, the sensor must be activated in menu 1.9.4.

If the room sensor is used in a room with underfloor heating, it should only have an indicative function, not control of the room temperature.

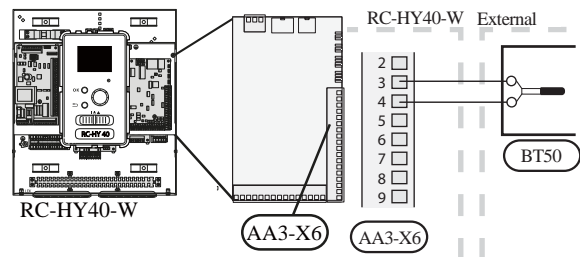

CAUTION

Changes of temperature in accommodation take time. For example, short time periods in combination with underfloor heating will not give a noticeable difference in room temperature.

- **Step controlled additional heat**

Refer to the explanation for RC-HY20-W (Page 35).

- **Relay output for emergency mode**

Refer to the explanation for RC-HY20-W (Page 35).

- **External circulation pump**

Refer to the explanation for RC-HY20-W (Page 36).

• **AUX inputs**

Up to 6 other external inputs are available on RC-HY40-W.

AUX1 through 3 correspond to the port 9/10, 11/12, 13/14 respectively on X6 terminal on AA3 board. AUX4 through 6 correspond to the port 1, 2 and 3 on X2 terminal on RC-HY40-W. Port 4 on X2 terminal is GND and is common to AUX4 through 6. Connect a sensor or switch between AUX and GND with a two-core cable with a minimum cross section of 0.5mm².

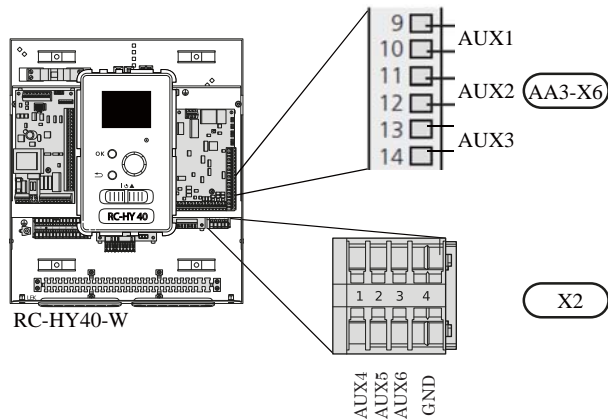

Select the appropriate function in menu 5.4.

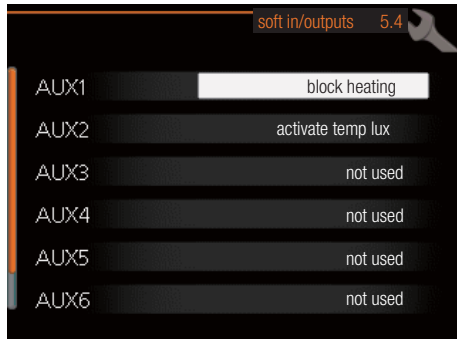

The following functions are available. For details, see AUX inputs for RC-HY20-W (Page 36)

- Temperature sensor, external supply at additional heat before reversing valve (BT63)
- Temperature sensor, cooling/heating (BT74)
- Temperature sensor, flow line cooling (BT64)
- Temperature sensor, boiler (BT52)
- Contact for external tariff blocking
- Switch for “SG ready”
- Contact for activation of “temporary lux”
- Contact for activation of “external adjustment”
- Switch for external alarm
- Switch for external blocking

• **AUX outputs**

External output is available on the port NC, NO and C on X7 terminal on AA3 board on RC-HY40-W. The relay output can have a max load of 2A at resistive load.

Following functions are available. Select the function in menu 5.4.

- Indication of buzzer alarm

When an alarm occurs, the circuit becomes closed between the port NO and C. During normal operation, the port NC and C is closed.

- Cooling mode indication / Active cooling mode (4-pipe cooling)

When the system turns into cooling mode, the circuit becomes closed between the port NO and C. By using this signal, it is possible to switch 3-way valve for 4-pipe cooling or to assemble a display circuit indicating cooling mode. For details of connecting the 3-way valve, refer to page 38.

- External pump control (GP10)

External pump (GP10) is used in case additional heater is placed after 3-way valve that switches heating/hot water (refer to page 25 for diagram).

Connect the circulation pump using the port NO and C on X7 terminal on AA3 board as shown below.

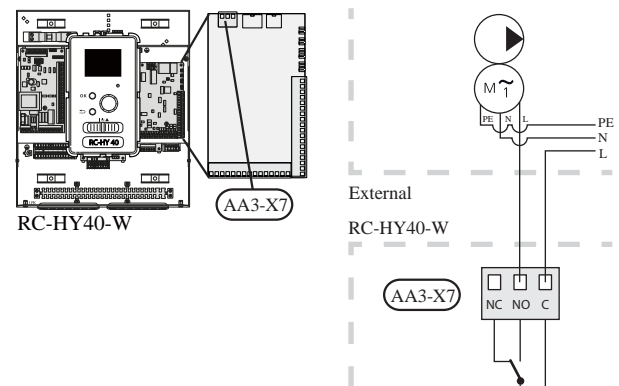

• **myUpway™**

Connect the network connected cable (straight, Cat.5e UTP) with RJ45-contact (male) to contact AA4-X9 on the display unit (as illustrated). Use the cable grommet (UB2) in the control module for cable routing.

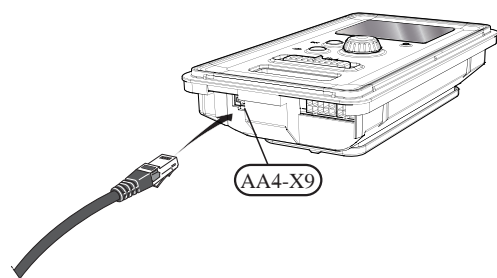

Commissioning and adjusting Preparations

Before starting commissioning, check the followings;

- The signal cable is connected between indoor unit and outdoor unit as well as indoor unit and controller according to the instruction.
- The power cable is connected to indoor unit, outdoor unit and controller according to the instruction.
- Operation switch in controller is in the position .
- The service valves on outdoor unit (QM35 and QM36) are open.
- Drain valve is closed before filling water in the system.
- Temperature limiter and electrical switch are not tripped.
- The system is filled with water and well vented.
- There are no leaks on the water pipe.

Filling and venting

Hot water tank

1. Open the hot water tap as well as venting valve if applicable, and then open the cold water cut-off valve at the inlet.
2. Fill the storage tank until obtaining uniform water outflow at the hot water tap, and then close the hot water tap and venting valve.
3. Fill the water heater coil in the tank. See Climate system for details.

After the installation and levelling the tank, follow the procedure below (for the connector pipe symbols, refer to page 15):

1. Remove protecting plugs from the connector pipes
2. Connect the hot water intake line (N).
3. Connect the cold water supply line together with the required safety valves (G).
4. If the system has the hot water circulation system, connect it to the connector pipe (L). Otherwise, plug the pipe.
5. Connect the supply (J) and return (H) of the heating medium to the coil.

CAUTION

If there is an electric heating module installed in the storage tank, fill the tank with water before connecting it to the electrical installation.

CAUTION

Open the hot water intake valves before heating the system up for the first time or after a longer break in its operation in order to check whether the storage tank is filled with water and the cut-off valve at the cold water inlet is not closed.

Climate system

1. Open the vent at the top of the heating system.
2. Open all shut-off valves, where installed, so that water flows into all circuits.
3. Open the valve for filling the heating circuit and fill it with water.
4. Close the vent when water comes out continuously without bubbles.
5. Check the manometer and close the filling valve when the pressure reaches the required value (2 bar is recommended).
6. Start the circulation pump of the heating system, and open the vent from time to time and release the all remaining air in the heating system.
7. Open safety valve until the pressure of the heating system drops down to about 1 bar. If the pressure drops below 1 bar during venting, add additional water in the circuit.

Inspection of installation

Current regulations require that the climate system is inspected before it is commissioned. The inspection must be carried out by a suitably qualified person and must be documented. Do not replace any part of the system without carrying out new checks.

Start-up and inspection

Before start-up

- 1 In case of cascade connection, check if each indoor unit has a unique address. See Cascade connection setting on page 31 for details.
2. Start commissioning by the following steps.

Commissioning with heat pump

Start guide is shown on the display on the controller when it is turned ON for the first time. Follow the start guide in the display, or choose menu 5.7 to show the start guide. For details, see Start guide on page 45-51.

Commissioning with additional heater only

Follow the start guide in the display as same as commissioning with heat pump, and then follow the list below.

1. Go to menu 4.2 op. mode.
2. Mark "add. heat only" using the control knob and then press the OK button.
3. Return to the main menus by pressing the Back button.

CAUTION

*When commissioning without MHI air/water heat pump an alarm communication error may appear in the display.
The alarm is reset if the relevant heat pump is deactivated in menu 5.2.2 ("installed heat pump").*

3-way valve operation check

1. Activate "AA2-K1 (QN10)" in menu 5.6.
2. Check that the reversing valve opens or is open for hot water charging.
3. Deactivate "AA2-K1 (QN10)" in menu 5.6.

AUX function check

To check any function connected to the AUX socket,

1. Activate "AA2-X4 (RC-HY20-W)" or "AA3-X7 (RC-HY40-W)" in menu 5.6.
2. Check the desired function.
3. Deactivate "AA2-X4 (RC-HY20-W)" or "AA3-X7 (RC-HY40-W)" in menu 5.6.

Cooling mode

In case the climate system contains a cooling circuit, activate cooling function in menu 5.11.1.1. After that, you can choose cooling mode indication in menu 5.4 for the AUX output.

Cleaning particle filter

Clean the particle filter (HQ1) after installation.

1. Close valve QM31 and the valve by the particle filter (HQ1).
2. Open the safety valve (QM20) to ensure that the pressure in HSB60-W drops.

3. Clean the particle filter (HQ1) as illustrated.

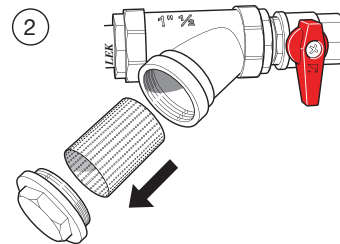
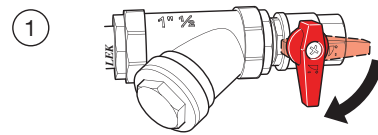

Secondary adjustment

Air is initially released from the hot water and venting may be necessary. If bubbling sounds can be heard from the heat pump, the circulation pump and radiators the entire system will require further venting. When the system is stable (correct pressure and all air eliminated) the automatic heating control system can be set as required

Start guide

NOTE

Fill in the climate system with water before the switch is set to "I".

1. Set the control module's switch to "I".
2. Follow the instructions in the start guide in the control module display. If the start guide does not start when you start the control module, start it manually in menu 5.7.

TIP

See page 52 for a more in-depth introduction to the installation's control system (operation, menus etc.).

Commissioning

The start guide is displayed when installation is started. It describes what needs to carry out at the first start together with basic settings during installation.

The start guide is displayed so that it cannot be bypassed in order to carry out the start-up correctly. You can start the start guide later in menu 5.7.

During the start-up guide, reversing valves and the shunt are run back and forth to help vent the heat pump.

CAUTION

As long as the start guide is active, no function in the heat pump will start automatically.

Each time the controller is ON, the guide will appear until it is completed on the last page.

Operation in the start guide

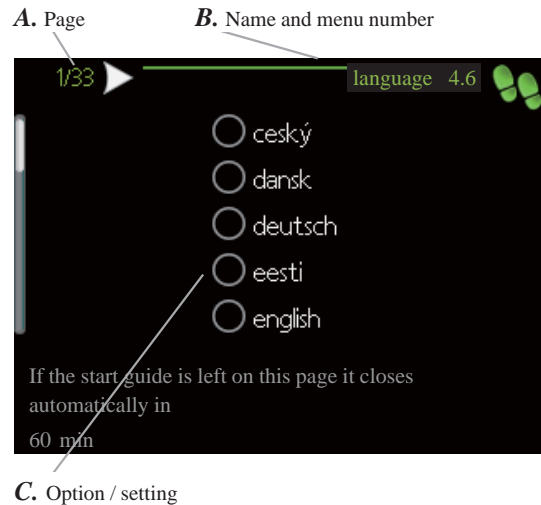

A. Page

You can see the current page of the start guide.

Scroll between the pages of the start guide as follows:

1. Turn the control knob until the arrow is marked in the top left corner (at the page number).
2. Press OK button to proceed to the next page in the start guide.

B. Name and menu number

You can see the menu name of this page. The number refers to the menu number in the control system.

To read more about affected menus, see the help menu or read the user manual.

C. Option / setting

Make settings for the system here.

D. Help menu

 In many menus there is a symbol indicating that extra help is available.

To access the help text:

1. Use the control knob to select the help symbol.
2. Press OK button.

The help text often consists of several windows that you can scroll between using the control knob.

Start guide - RC-HY20-W

This menu is shown at the first time that the heat pump is started. It ensures that commissioning is carried out correctly and all necessary steps are followed.

The following menus are basic settings. If accessories are connected other menus will appear.

1/18 - Language

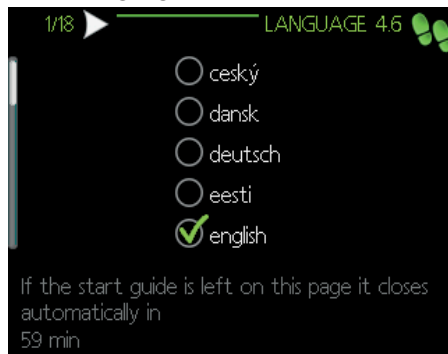

Select the language of the controller.

Factory setting: English

Available languages: Czech, Danish, German, Estonian, English, Spanish, French, Croatian, Icelandic, Italian, Latvian, Lithuanian, Hungarian, Dutch, Norwegian, Polish, Romanian, Russian, Slovenian, Finnish, Swedish, Turkish.

2/18 - Start guide

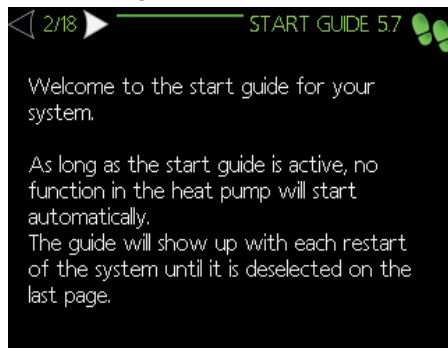

This menu displays information about the start guide.

No action needed.

3/18 - Country

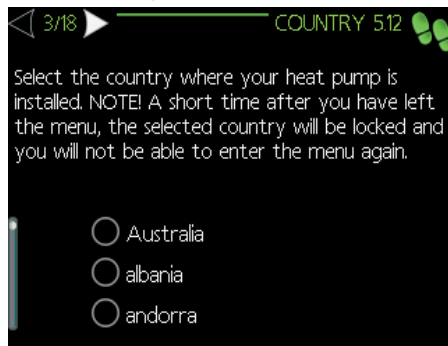

Select the country where your heat pump is located.

4/18 - Flow set. climate sys.

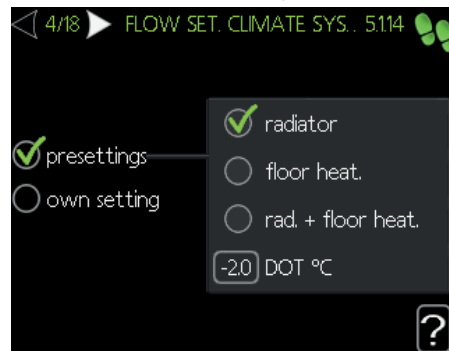

The type of heating distribution system the heating medium pump works towards is set here.

Factory setting: Presettings - Radiator

Setting range:

- **Presettings**

- Radiator
- Floor heating
- Rad. + floor heat

- **Own setting**

- Setting range dt at DOT: 0.0 - 25.0°C
- Setting range DOT: -40.0 - 20.0°C

Where dt at DOT is the difference in degrees between the flow and return temperature at dimensioned outdoor temperature.

5/18 - Accessories

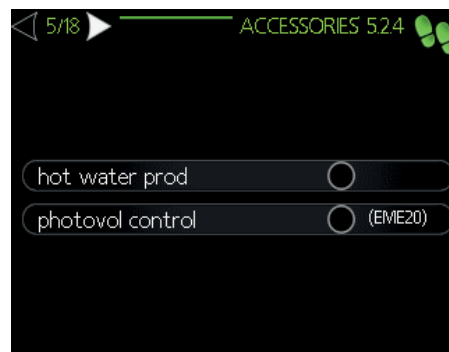

Activate additional connected accessories here.

Setting range: hot water prod, photovol control (EME20)

6/18 - Soft in/outputs

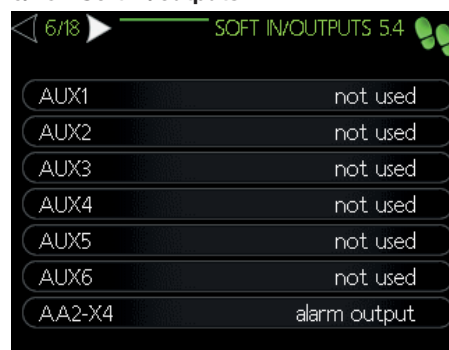

Commissioning and adjusting

Set the function of each input and output for each terminal (if connected)

Setting range:

- **Aux 1-6**
 - Temperature sensor, cooling/heating (BT74)
 - Temperature sensor, external return line (BT71)
 - Temperature sensor, flow line cooling (BT64)
 - Contact for external tariff blocking
 - Switch for "SG Ready"
 - Contact for activation of "external adjustment"
 - Switch for external alarm
 - Switch for external blocking
- **AA2-X4**
 - Alarm output
 - Cooling mode indication
 - Active cooling 4 pipe
 - External heating medium pump (GP10)
 - Hot water circulation (GP11)

7/18 - Room sensor settings

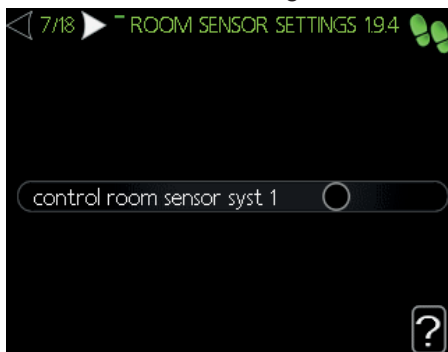

Activate and set the room temperature sensor RTS40M (if connected)

8/18 - Start guide

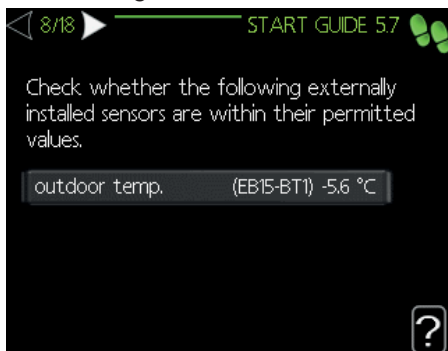

Check if the values of the shown temperature sensors are correct.

9/18 - Addition

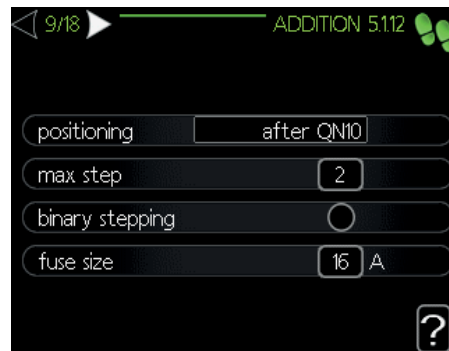

Set addition settings here.

Factory setting:

- **Positioning:** Before QN10
- **Max step:** 3
- **Fuse size:** 16A

Setting range:

- **Positioning:**
 - Before QN10
 - After QN10
- **Max step:**
 - Binary stepping deactivated: 0-3
 - Binary stepping activated: 0-7
- **Fuse size:** 11-200A

10/18 - Installed heat pump

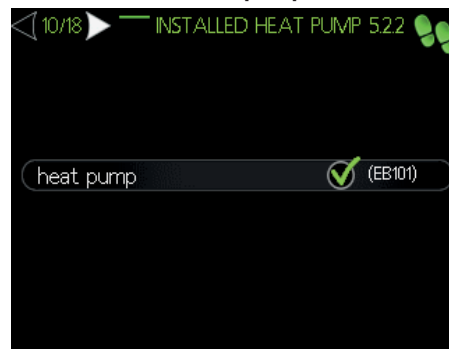

Enable heat pump (EB101) here.

11/18 - Time & date

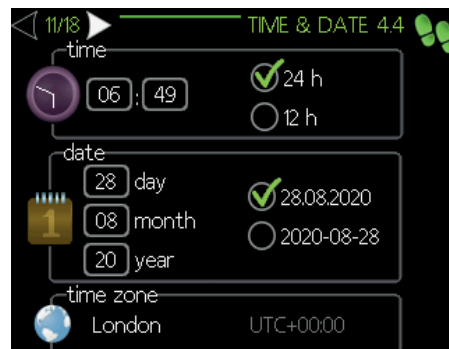

Set time, date and time zone here.

If the system is connected to myUpway then time and date are

set automatically.

12/18 - Mln. flow line temperature

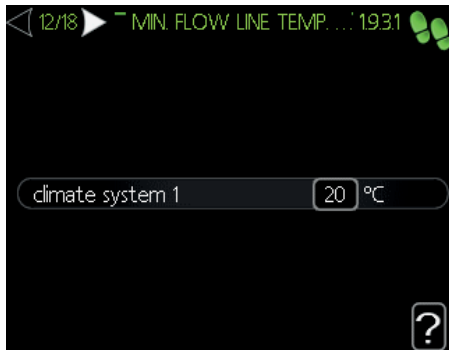

Set the minimum flow line temperature of the climate system.

Factory setting: 20°C

Setting range: 5-70°C

13/18 - Max. flow line temperature

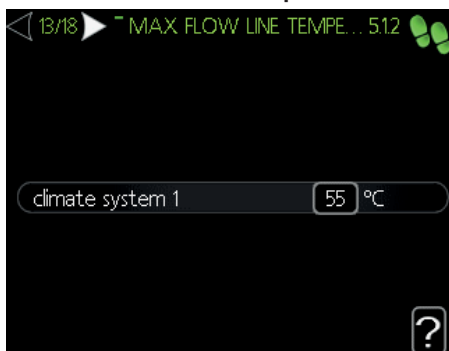

Set the maximum flow line temperature of the climate system.

Factory setting: 60°C

Setting range: 5-70°C

14/18 - Heating curve

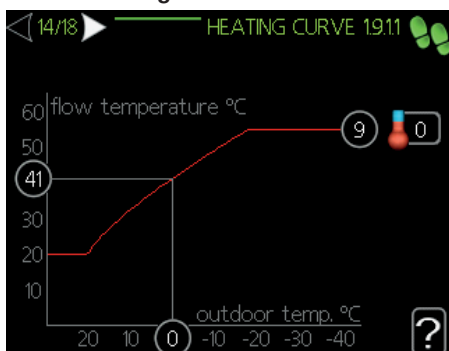

View and set (if desired) the space heating curve.

15/18 - Op. mode

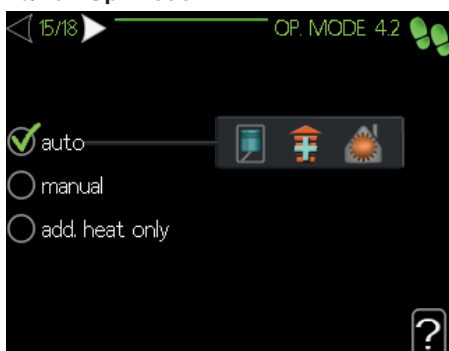

Set the operating mode of the heat pump.

Factory setting: Auto

Setting range:

- Auto
- Manual
 - Heating
 - Cooling
 - Add. heat only
- Add. heat only
 - Heating

16/18 - Alarm actions

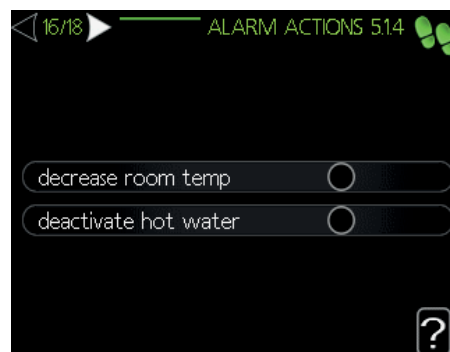

Set how to control the heat pump in case of alarm.

17/18 - Start guide

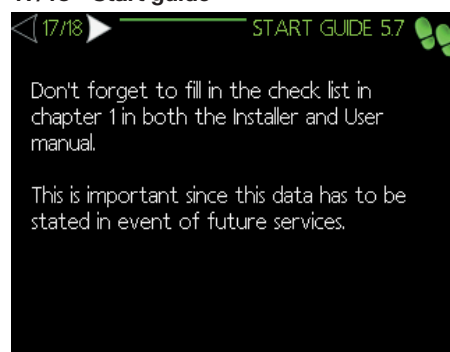

Information message from the controller. No action needed.

18/18 - Start guide

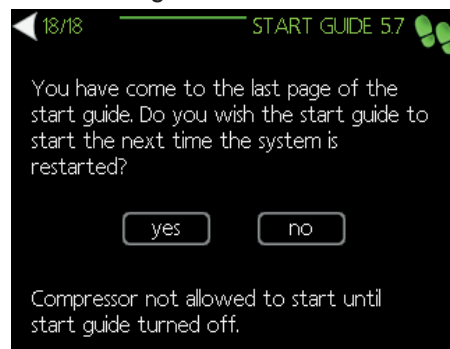

Commissioning guide finishes here. You can set it to open again upon restart of the controller or do not open it anymore.

Start guide - RC-HY40-W

This menu is shown at the first time that the heat pump is started. It ensures that commissioning is carried out correctly and all necessary steps are followed.

The following menus are basic settings. If accessories are connected other menus will appear.

1/19 - Language

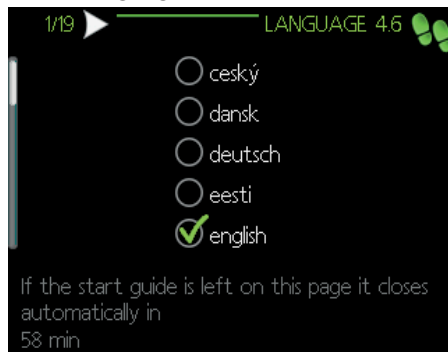

Select the language of the controller.

Factory setting: English

Available languages: Czech, Danish, German, Estonian, English, Spanish, French, Croatian, Icelandic, Italian, Latvian, Lithuanian, Hungarian, Dutch, Norwegian, Polish, Romanian, Russian, Slovenian, Finnish, Swedish, Turkish.

2/19 - Start guide

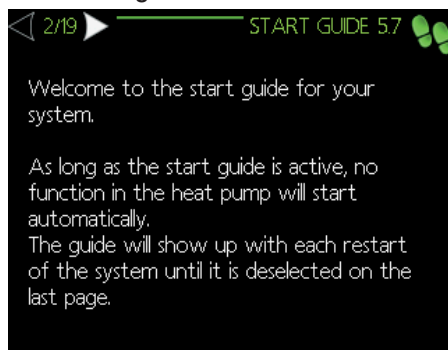

This menu displays information about the start guide.

No action needed.

3/19 - Country

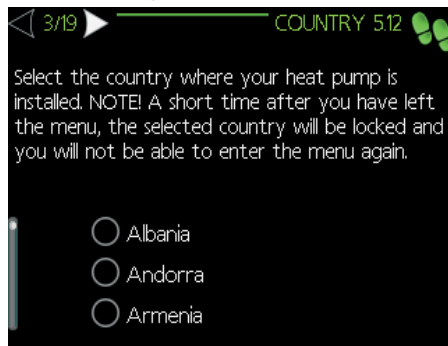

Select the country where your heat pump is located.

4/19 - Flow set. climate sys.

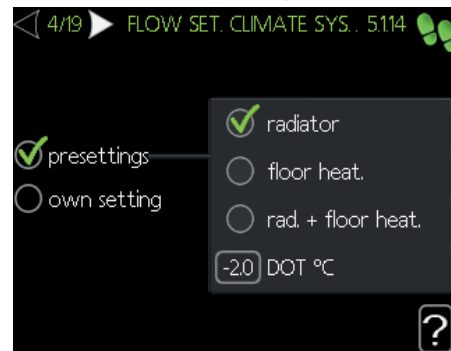

The type of heating distribution system the heating medium pump works towards is set here.

Factory setting: Presettings - Radiator

Setting range:

- **Presettings**

- Radiator
- Floor heating
- Rad. + floor heat

- **Own setting**

- Setting range dt at DOT: 0.0 - 25.0°C
- Setting range DOT: -40.0 - 20.0°C

Where dt at DOT is the difference in degrees between the flow and return temperature at dimensioned outdoor temperature.

5/19 - Accessories

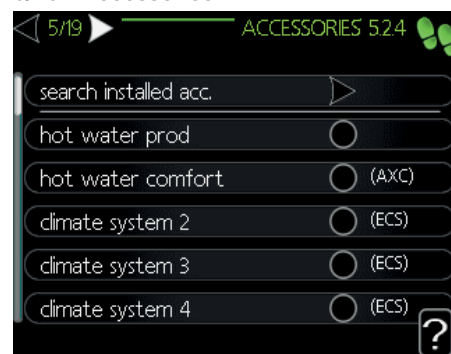

Activate or search for additional connected accessories here.

6/19 - Soft in/outputs



Set the function of each input and output for each terminal (if connected)

Setting range:

- **Aux 1-6**
 - Temperature sensor, cooling/heating (BT74)
 - Temperature sensor, heating supply downstream the submersible heater (BT63)
 - Temperature sensor, flow line cooling (BT64)
 - Temperature sensor, boiler (BT52)
 - Contact for external tariff blocking
 - Switch for "SG Ready"
 - Contact for activation of "external adjustment"
 - Switch for external alarm
 - Switch for external blocking
- **AA3-X7**
 - Alarm output
 - Cooling mode indication
 - Active cooling 4 pipe
 - External heating medium pump (GP10)
 - Hot water circulation (GP11)

7/19 - Room sensor settings

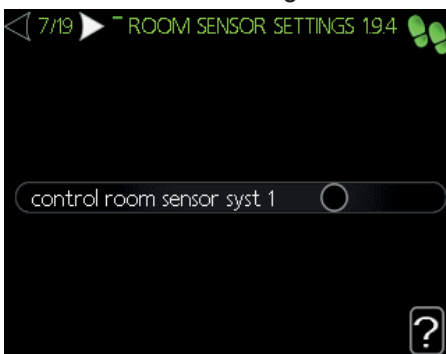

Activate and set the room temperature sensor RTS40M (if connected) for each climate system

8/19 - Start guide

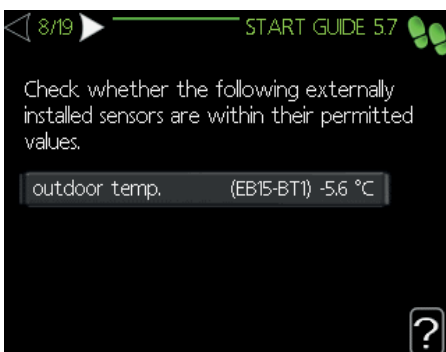

Check if the values of the shown temperature sensors are correct.

9/19 - Addition

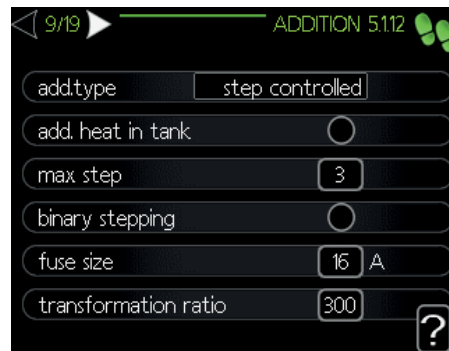

Set addition settings here.

Factory setting:

- **Positioning:** Before QN10
- **Max step:** 3
- **Fuse size:** 16A
- **Transformation ration:** 16A

Setting range:

- **Add. tupe:**
 - step controlled
 - shunt controlled
- **Positioning:**
 - Before QN10
 - After QN10
- **Max step:**
 - Binary stepping deactivated: 0-3
 - Binary stepping activated: 0-7
- **Fuse size:** 11-200A
- **Transforamtion ratio:** 300-3000

10/19 - Installed slaves

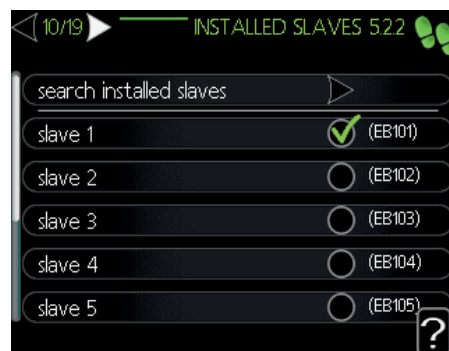

Search for installed slaves and enable them (if connected) here. If everything is correct the units are automatically selected after searching for installed slaves.

11/19 - Docking

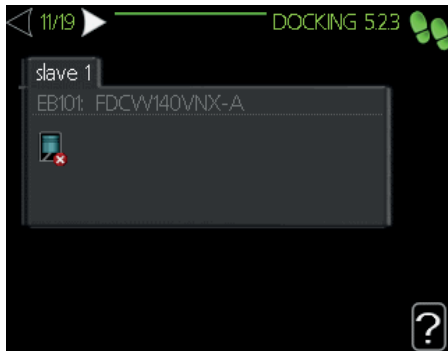

Set docking for each slave (if installed).

12/19 - Time & date



Set time, date and time zone here.

If the system is connected to myUpway then time and date are set automatically.

13/19 - Min. flow line temperature

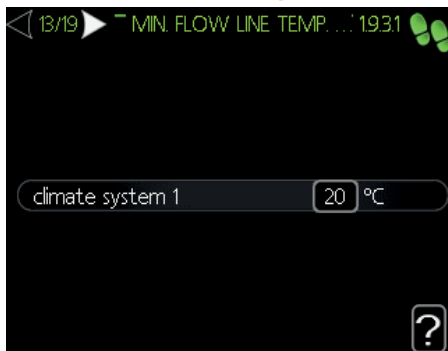

Set the minimum flow line temperature of the climate system.

Factory setting: 20°C

Setting range: 5-70°C

14/19 - Max. flow line temperature

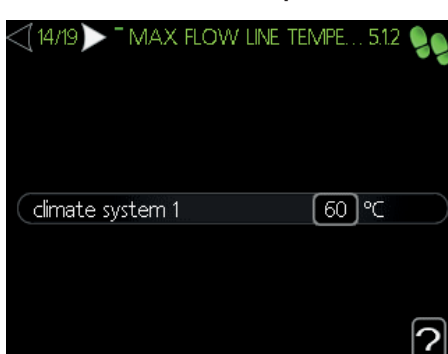

Set the maximum flow line temperature of the climate system.

Factory setting: 60°C

Setting range: 5-70°C

15/19 - Heating curve

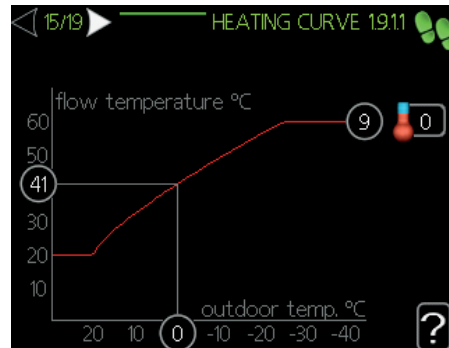

View and set (if desired) the space heating curve.

16/19 - Op. mode

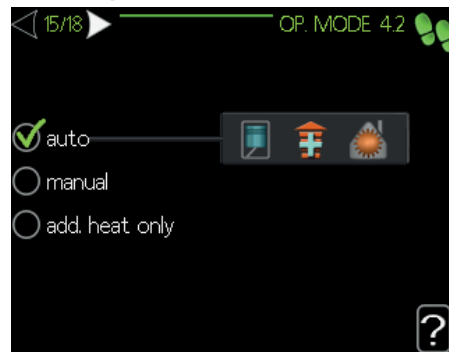

Set the operating mode of the heat pump.

Factory setting: Auto

Setting range:

- Auto
- Manual
 - Heating
 - Cooling
 - Add. heat only
- Add. heat only
 - Heating

17/19 - Alarm actions

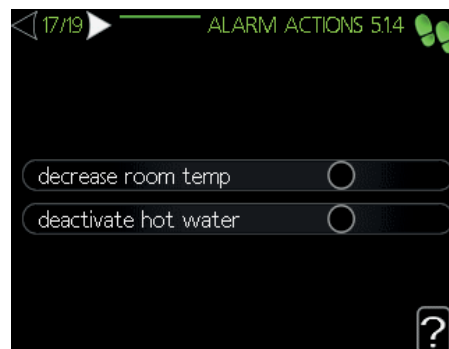

Set how to control the heat pump in case of alarm.

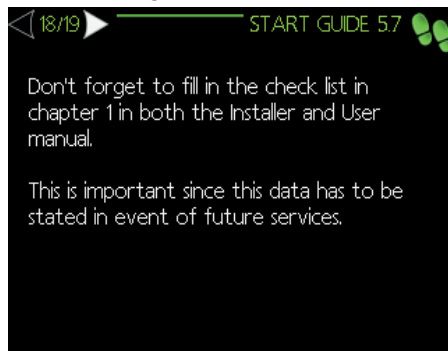
18/19 - Start guide

Information message from the controller. No action needed.

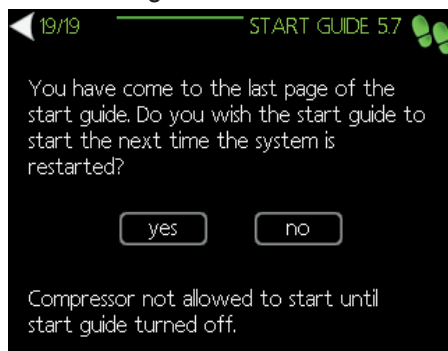
19/19 - Start guide

Commissioning guide finishes here. You can set it to open again upon restart of the controller or do not open it anymore.

Heating/cooling curve setting

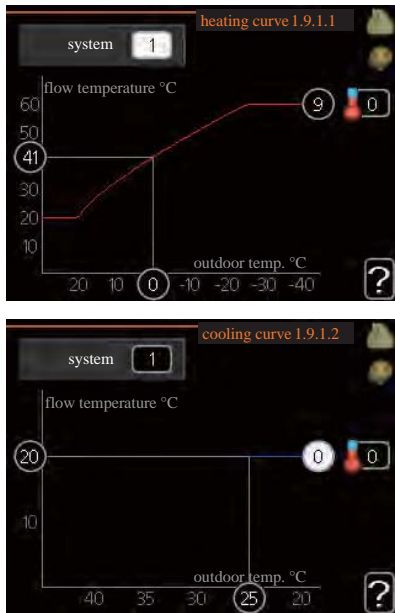

heating curve

Setting range: 0 – 15

Default value: 9

cooling curve (accessory required)

Setting range: 0 – 9

Default value: 0

The prescribed heating curve for your house can be viewed in the menu heating curve . The task of the heating curve is to give an even indoor temperature, regardless of the outdoor temperature, and thereby energy efficient operation. From this heating curve, the control module determines the temperature of the water to the heating system, supply temperature, and there by the indoor temperature. Select the heating curve and read off how the supply temperature changes at different outdoor temperatures here. If there is cooling function, the same settings can be made for the cooling curve.

Curve coefficient

The heating/cooling curve shows the relation between the target supply temperature and the corresponding outdoor temperature. A steep curve indicates that supply temperature becomes higher at low outdoor air temperature in heating and it becomes lower at high outdoor air temperature in cooling.

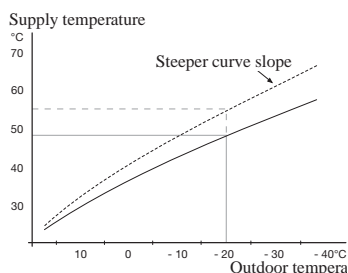

The optimum slope depends on the climate conditions in your location, the type of heating device (radiators or under floor heating) and how well insulated the house is.

The curve is set when the heating installation is installed, but may need adjusting later. Normally, the curve will not need further adjustment.

CAUTION

In the event of making fine adjustments of the indoor temperature, the curve must be offset up or down instead, this is done in menu 1.1 temperature .

Curve offset

The target temperature can be offset in parallel over the entire outdoor temperature range by this function. This is offset by 5 °C by adjusting 2 steps.

The target temperature can be parallel offset in the entire outdoor temperature range with this function. It is offset by 5 °C by adjusting 2 steps.

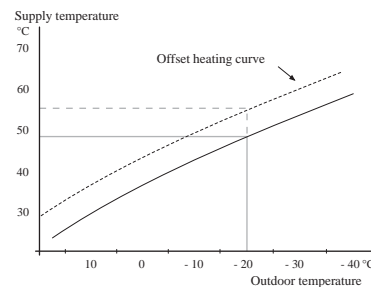

Flow line temperature – maximum and minimum values

This function is used in order to limit max-min supply temperature. The heating / cooling curve becomes flat beyond max / min target temperature.

CAUTION

Underfloor heating systems are normally max flow line temperature set between 35 and 45°C. Take care not to cause low temperature burns in case it is set higher than 35°C.

Must be restricted with underfloor cooling min. flow line temp. to prevent condensation.

Check the max temperature for your floor with your installer/floor supplier.

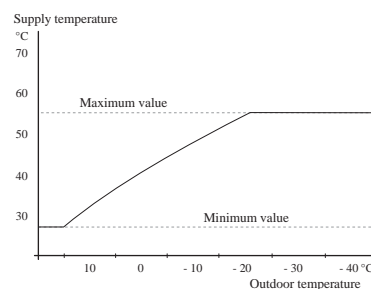

The figure at the end of the curve indicates the curve number. The figure beside the thermometer icon gives the curve offset. Use the control knob to set a new value.

Confirm the new setting by pressing the OK button.

Curve 0 is an own curve created in menu 1.9.7.

To select another curve (slope):

1. Press OK button to access the setting mode
2. Select a new curve. The curves are numbered from 0 to 15, and the bigger number curve has steeper slope.
Curve 0 means that own curve (menu 1.9.7) is used.
3. Press OK button to exit the setting.

To read off a curve:

1. Turn the control knob so that the ring on the shaft with the outdoor temperature is marked.
2. Press OK button.
3. Follow the grey line up to the curve and out to the left to read off the value for the supply temperature at the selected outdoor temperature.
4. You can now select to take read outs for different outdoor temperatures by turning the control knob to the right or left and read off the corresponding flow temperature.
5. Press OK or Back button to exit read off mode.

TIP

Wait 24 hours before making a new setting, so that the room temperature has time to stabilise.

If it is cold outdoors and the room temperature is too low, increase the curve slope by one increment.

If it is cold outdoors and the room temperature is too high, lower the curve slope by one increment.

If it is warm outdoors and the room temperature is too low, increase the curve offset by one increment.

If it is warm outdoors and the room temperature is too high, lower the curve offset by one increment.

Hot water circulation setting

hot water recirc.

operating time

Setting range: 1 – 60 min

Default value: 60 min

downtime

Setting range: 0 – 60 min

Default value: 0 min

Set the hot water circulation for up to three periods per day here. During the set periods the hot water circulation pump will run according to the settings above.

"operating time" decide how long the hot water circulation pump must run per operating instance.

"downtime" decide how long the hot water circulation pump must be stationary between operating instances.

Hot water circulation is activated in menu 5.4 "soft inputs and outputs".

SG Ready

This function can only be used in mains networks that support the "SG Ready"-standard .

Make settings for the function "SG Ready" here.

Low price mode means that the electricity supplier has a low tariff and the system uses this to reduce costs.

Over capacity mode means that the electricity supplier has set the tariff very low and the system uses this to reduce the costs as much as possible.

affect room temperature

Here you set whether room temperature should be affected when activating "SG Ready".

With low price mode of "SG Ready" the parallel offset of the indoor temperature is increased by "+1". If a room sensor is installed and activated, the desired room temperature increases by 1 °C.

With over capacity mode of "SG Ready" the parallel offset for the indoor temperature is increased by "+2".

If a room sensor is installed and activated, the desired room temperature increases by 2 °C.

affect hot water

Here you set whether the temperature of the hot water should be affected when activating "SG Ready".

With low price mode on "SG Ready" the stop temperature of the hot water is set as high as possible at only compressor operation (immersion heater not permitted).

With over capacity mode of "SG Ready" the hot water is set to "luxury" (immersion heater permitted).

affect cooling (accessory required)

Here you set whether room temperature during cooling operation should be affected when activating "SG Ready".

With low price mode of "SG Ready" and cooling operation the indoor temperature is not affected.

With over capacity mode of "SG Ready" and cooling operation the parallel offset for the indoor temperature is reduced by "-1". If a room sensor is installed and activated, the desired room temperature decreases by 1 °C.

NOTE

The function must be connected to two AUX inputs and activated in menu 5.4.

Control Display unit

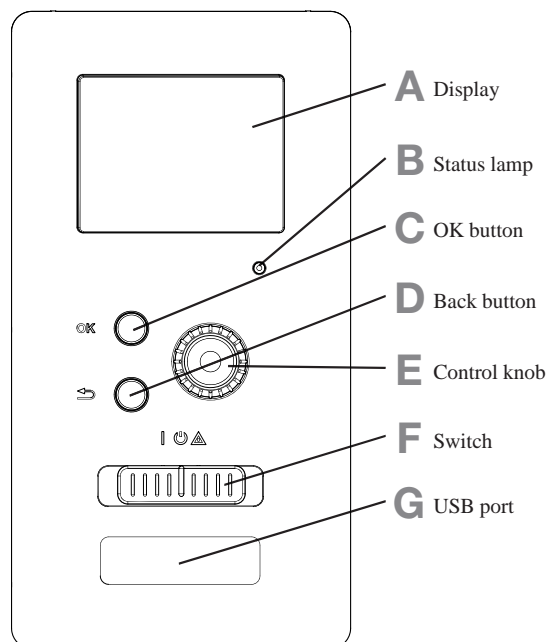

A Display

Instructions, settings and operational information are shown on the display. The easy-to-read display and menu system, make it easy to navigate between various menus and options, set comfort and get the necessary information.

B Status lamp

The status lamp indicates the status of the control module. It:

- lights green during normal operation.
- lights yellow in emergency mode.
- lights red in the event of an alarm.

C OK button

The OK button is used to:

- confirm selections of sub menus/options/set values/page in the start guide.

D Back button

The back button is used to:

- go back to the previous menu.
- change a setting that has not been confirmed.

E Control knob

The control knob can be turned to the right or left. You can:

- scroll in menus and between options.
- increase and decrease values.
- change pages in multiple page instructions (for example help text and service info).

F Switch (SF1)

The switch shows three positions:

- On (I)
- Standby (⏻)
- Emergency mode (⚠)

Emergency mode must only be used in the event of a fault on the control module. In this mode, the compressor in the heat pump is turned off and the immersion heater is activated.

The control module display is not illuminated and the status lamp lights yellow.

G USB port

The USB port is hidden behind the plastic badge of the product name.

The USB port is used to update the software.

Menu system

RC-HY20-W

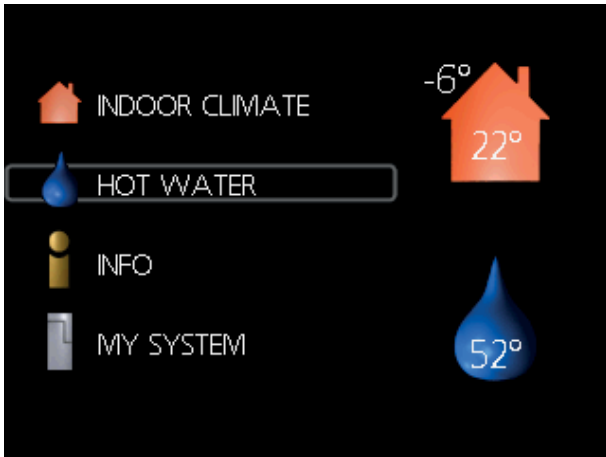

RC-HY40-W



Menu 1 - INDOOR CLIMATE

Setting and scheduling the indoor climate. See information in the help menu or user manual.

Menu 2 - HOT WATER

Setting and scheduling hot water production. See information in the help menu or user manual.









This menu only appears if a water heater is installed in the system.

Menu 3 - INFO

Display of temperature and other operating information and access to the alarm log. See information in the help menu or user manual.

Symbols in the display

The following symbols can appear in the display during operation.

Symbol	Description
	This symbol appears when there is information to be noticed in menu 3.1.
	<p>These two symbols indicate whether the compressor in the outdoor unit or additional heat in the installation is blocked via controller.</p> <p>These functions will be blocked for example, when either of the operation mode is blocked in menu 4.2, when blocking of either function is scheduled in menu 4.9.5, or when an alarm for blocking the operation occurs.</p>
	Blocking the compressor.
	Blocking additional heat.
	This symbol appears if periodic increase or lux mode for the hot water is activated.
	This symbol indicates if "holiday setting" is active in menu 4.7.
	This symbol indicates if the controller has contact with myUpway.
	This symbol indicates if cooling is active.

Menu 4 - MY INSTALLATION

Setting time, date, language, display, operating mode etc. See information in the help menu or user manual.

Menu 5 - SERVICE

Advanced settings. These settings are not available to the end user. The menu is made visible by pressing the Back button for 7 seconds in the top screen.

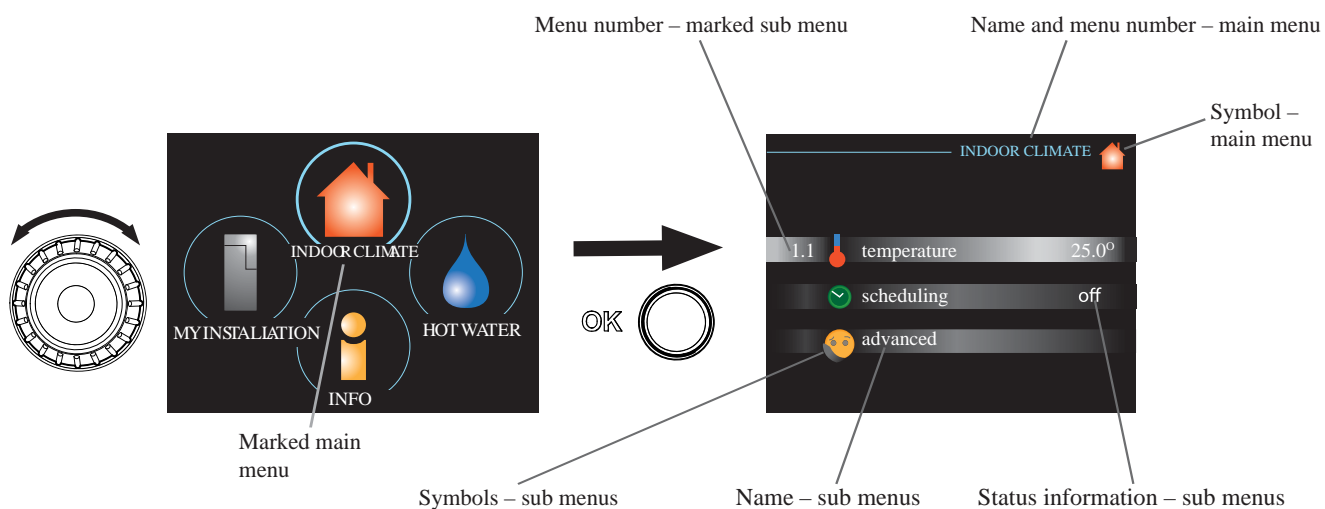

Operation

To move the cursor, turn the control knob to the left or the right. The marked position is brighter and/or has a light frame.

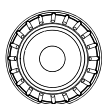

Selecting menu

To advance in the menu system select a main menu by marking it and then pressing the OK button. A new window opens with sub menus.

Select one of the sub menus by marking it and then pressing the OK button.

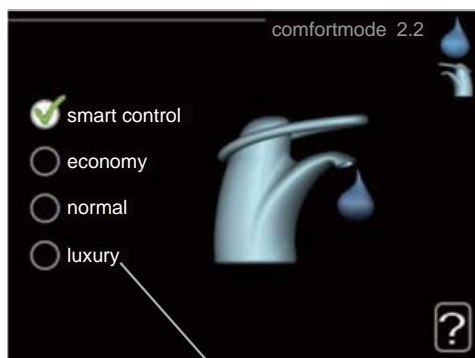

Selecting options



Alternative

In an options menu the current selected option is indicated by a green tick. 

To select another option:





1. Mark the applicable option. One of the options is pre-selected (white). 
2. Press the OK button to confirm the selected option. The selected option has a green tick. 

Setting a value



Values to be changed

To set a value:

1. Mark the value you want to set using the control knob. 
2. Press the OK button. The background of the value becomes green, which means that you have accessed the setting mode. 
3. Turn the control knob to the right to increase the value and to the left to reduce the value. 
4. Press the OK button to confirm the value you have set. To change and return to the original value, press the Back button. 

Use the virtual keyboard

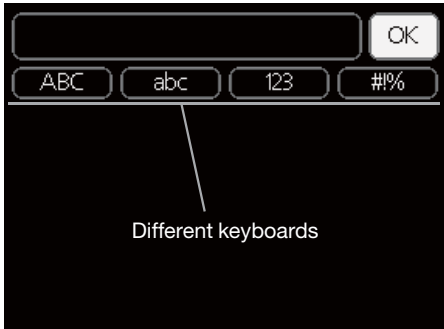

In some menus where text may require entering, a virtual keyboard is available.



Depending on the menu, you can gain access to different character sets which you can select using the control knob. To change character table, press the Back button. If a menu only has one character set, the keyboard is displayed directly.

When you have finished writing, mark "OK" and press the OK button.

Scroll through the windows

A menu can consist of several windows. Turn the control knob to scroll between the windows.

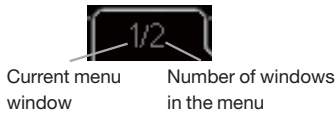

Scroll through the windows in the start guide

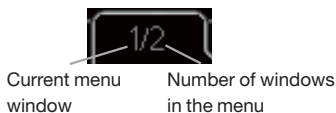

1. Turn the control knob until one of the arrows in the top left corner (at the page number) has been marked.
2. Press the OK button to skip between the steps in the start guide.

Help menu

? In many menus there is a symbol that indicates that extra help is available.

To access the help text:

1. Use the control knob to select the help symbol.
2. Press the OK button.

The help text often consists of several windows that you can scroll between using the control knob.

Menu list

** Accessories are needed. ** Heat pump with cooling function required. 40"

MENU		RC-HY20-W	RC-HY40-W		
1 INDOOR CLIMATE					
1.1 - temperature	1.1.1 heating	✓	✓		
	1.1.2 cooling **	✓	✓		
1.3 - scheduling	1.3.1 heating	✓	✓		
	1.3.2 cooling **	✓	✓		
1.9 - advanced	1.9.1 curve	1.9.1.1 heating curve	✓	✓	
		1.9.1.2 cooling curve **	✓	✓	
	1.9.2 external adjustment	✓	✓		
	1.9.3 min. flow line temp.	1.9.3.1 heating	✓	✓	
		1.9.3.2 cooling **	✓	✓	
	1.9.4 room sensor settings	✓	✓		
	1.9.5 cooling settings *	✓	✓		
	1.9.7 own curve	1.9.7.1 heating	✓	✓	
		1.9.7.2 cooling **	✓	✓	
1.9.8 point offset	✓	✓			
2 HOTWATER					
2.1 temporary lux		✓	✓		
2.2 comfort mode		✓	✓		
2.3 scheduling		✓	✓		
2.9 advanced	2.9.1 periodic increase	✓	✓		
	2.9.2 hot water recirc. *	✓	✓		
3 INFO					
3.1 service info		✓	✓		
3.2 compressor info		✓	✓		
3.3 add. heat info		✓	✓		
3.4 alarm log		✓	✓		
3.5 indoor temp. log		✓	✓		
4. MY SYSTEM					
4.1 plus functions	4.1.1 Pool 1		—	✓	
	4.1.2 Pool 2		—	✓	
	4.1.3 internet	4.1.3.1 myUpway™	✓	✓	
		4.1.3.8 tcp/ip settings	✓	✓	
		4.1.3.9 proxy settings	✓	✓	
	4.1.5 SG Ready		✓	✓	
	4.1.6 smart price adaption™		✓	✓	
	4.1.8 smart energy source™	4.1.8.1 settings		—	✓
		4.1.8.2 set. Price		—	✓
		4.1.8.3 CO2 impact		—	✓
4.1.8.4 tariff periods, electricity		—	✓		
4.1.8.6 tariff per, ext. shunt add		—	✓		

** Accessories are needed. ** Heat pump with cooling function required. 40"

MENU		RC-HY20-W	RC-HY40-W
	4.1.8.7 tariff per, ext. step add	—	✓
	4.1.10 Solar electricity	✓	✓
4.2 op. mode		✓	✓
4.3 my icons		✓	✓
4.4 time & date		✓	✓
4.6 language		✓	✓
4.7 holiday setting		✓	✓
4.9 advanced	4.9.1 op. prioritisation	✓	✓
	4.9.2 auto mode setting	✓	✓
	4.9.3 degree minute setting	✓	✓
	4.9.4 factory setting user	✓	✓
	4.9.5 schedule blocking	✓	✓
	4.9.6 schedule silent mode	✓	✓
5 SERVICE			
5.1 operating settings	5.1.1 hot water settings *	✓	✓
	5.1.2 max flow line temperature	✓	✓
	5.1.3 max diff flow line temp.	✓	✓
	5.1.4 alarm actions	✓	✓
	5.1.12 addition	✓	✓
	5.1.14 flow set. climate system	✓	✓
	5.1.22 heat pump testing	✓	✓
	5.1.23 compressor curve	✓	✓
5.2 system settings	5.2.2 installed slaves	✓	✓
	5.2.3 docking	✓	✓
	5.2.4 accessories	✓	✓
5.3 accessory settings	5.3.2 shunt controlled add. heat *	—	✓
	5.3.3 extra climate system *	—	✓
	5.3.4 solar heating *	—	✓
	5.3.6 step controlled add. heat	—	✓
	5.3.8 hot water comfort *	—	✓
	5.3.10 modbus *	—	✓
	5.3.20 flow sensor*	—	✓
5.4 soft in/outputs		✓	✓
5.5 factory setting service		✓	✓
5.6 forced control		✓	✓
5.7 start guide		✓	✓
5.8 quick start		✓	✓
5.9 floor drying function		✓	✓
5.10 change log		✓	✓

** Accessories are needed. ** Heat pump with cooling function required. 40"

MENU		RC-HY20-W	RC-HY40-W
5.11 slave settings	5.11.1 EB101	5.11.1.1 heat pump	✓
		5.11.1.2 charge pump (GP12)	✓
	5.11.2 EB102	—	✓
	5.11.3 EB103	—	✓
	5.11.4 EB104	—	✓
	5.11.5 EB105	—	✓
	5.11.6 EB106	—	✓
	5.11.7 EB107	—	✓
	5.11.8 EB108	—	✓
5.12 country		✓	✓

Sub-menus

Menu SERVICE has orange text and is intended for the advanced user. This menu has several sub-menus.

Status information for the relevant menu can be found on the display to the right of the menus.

operating settings: Operating settings for the control module.

system settings: System settings for the control module, activating accessories etc.

soft in/outputs: Setting software controlled in and outputs on the input card (AA3) and terminal block (X2).

factory setting service: Total reset of all settings (including settings available to the user) to default values.

forced control: Forced control of the different components in the indoor module.

start guide: Manual start of the start guide which is run the first time when the control module is started.

quick start: Quick starting the compressor.

NOTE

Incorrect settings in the service menus can damage the installation.

Menu 5.1 - operating settings

Operating settings can be made for the control module in the sub menus.

Menu 5.1.1 - hot water settings

economy

Setting range start temp. economy: 5 – 55 °C

Factory setting start temp. economy: 42 °C

Setting range stop temp. economy: 5 – 60 °C

Factory setting stop temp. economy: 48 °C

normal

Setting range start temp. normal: 5 – 60 °C

Factory setting start temp. normal: 46 °C

Setting range stop temp. normal: 5 – 65 °C

Factory setting stop temp. normal: 50 °C

luxury

Setting range start temp. lux: 5 – 70 °C

Factory setting start temp. lux: 49 °C

Setting range stop temp. lux: 5 – 70 °C

Factory setting stop temp. lux: 53 °C

stop temp. per. increase

Setting range: 55 – 70 °C

Factory setting: 55 °C

charge method

Setting range: target temp, delta temp

Default value: delta temp

Here you set the start and stop temperature of the hot water for the different comfort options in menu 2.2 as well as the stop temperature for periodic increase in menu 2.9.1.

The charge method for hot water mode is selected here. "delta temp" is recommended for heaters with charge coil, "target temp" for heaters with domestic coil.

Menu 5.1.2 - max flow line temperature

climate system

Setting range: 5 – 70 °C

Default value: 60 °C

Set the maximum supply temperature for the climate system here. If the installation has more than one climate system, individual maximum supply temperatures can be set for each system. Climate systems 2 – 8 cannot be set to a higher max supply temperature than climate system 1.

CAUTION

Underfloor heating systems are normally max flow line temperature set between 35 and 45°C.

Be careful not to cause low temperature burn if it is set at 35°C or higher.

Check the max floor temperature with your floor supplier.

Menu 5.1.3 - max diff flow line temp.**max diff compressor**

Setting range: 1 – 25 °C

Default value: 10 °C

max diff addition

Setting range: 1 – 24 °C

Default value: 7 °C

Here you set the maximum permitted difference between the calculated and actual supply temperature during compressor mode and add. heat mode. Max diff. additional heat can never exceed max diff. compressor

max diff compressor

When the current supply temperature **deviates** from the set value compared to that calculated, the heat pump is forced to stop irrespective of the degree minute value.

If the current supply temperature exceeds the calculated flow temperature plus the set value, the degree minute value is set to 0. The compressor in the heat pump stops when there is only a heating demand.

max diff addition

If "addition" is selected and activated in menu 4.2 and the present supply temp exceeds the calculated temperature plus the set value, the additional heat is forced to stop.

Menu 5.1.4 - alarm actions

Select how to control the heat pump in the event of an alarm. You can choose to stop producing hot water and/or reduce the room temperature.

CAUTION

If no alarm action is selected, it can result in higher energy consumption in the event of an alarm.

Menu 5.1.12 - addition

add type: step controlled

max step

Setting range (binary stepping deactivated): 0 – 3

Setting range (binary stepping activated): 0 – 7

Default value: 3

fuse size

Setting range: 1 – 200 A

Factory setting: 16 A

You can set the maximum number of permitted additional heat steps, if there is internal additional heat in the tank (only accessible if the additional heat is positioned after QN10), whether binary stepping is to be used and the size of the fuse.

<Add. Type: shunt controlled (RC-HY40-W only)>**prioritised additional heat**

Setting range: on/off

Factory setting: off

minimum running time

Setting range: 0 – 48 h

Default value: 12 h

min temp.

Setting range: 5 – 90 °C

Default value: 55 °C

mixing valve amplifier

Setting range: 0.1 – 10.0

Default value: 1.0

mixing valve step delay

Setting range: 10 – 300 s

Default values: 30 s

fuse size

Setting range: 1 – 200 A

Factory setting: 16 A

transformation ratio

Setting range: 300 – 3000

Factory setting: 300

Select this option if shunt controlled additional heat is connected.

Set when the addition is to start, the minimum run time and the minimum temperature for external addition with shunt here. External addition with shunt is for example a wood/oil/gas/pellet boiler.

You can set shunt valve amplification and shunt valve waiting time.

Selecting "prioritised additional heat" uses the heat from the external additional heat instead of the heat pump.

The shunt valve is regulated as long as heat is available, otherwise the shunt valve is closed.

TIP

See the accessory installation instructions for function description.

Menu 5.1.14 - flow set. climate system**presettings**

Setting range: radiator, floor heat., rad. + floor heat.

Default value: radiator

Setting range DOT: -40.0 – 20.0 °C

The factory setting of DOT value depends on the country that has been given for the product's location.

The example below refers to Sweden.

Factory setting DOT: -20.0 °C

own setting

Setting range dT at DOT: 0.0 – 25.0

Factory setting dT at DOT: 10.0
 Setting range DOT: -40.0 – 20.0 °C
 Factory setting DOT: -20.0 °C

Select the type of heating distribution system.

dT at DOT is the difference in degrees between flow and return temperatures at dimensioned outdoor temperature.

Menu 5.1.22 - heat pump testing

NOTE

*This menu is intended for testing heat pump according to different standards.
 Use of this menu for other reasons may result in your installation not functioning as intended.*

This menu contains several sub-menus, one for each standard.

Menu 5.1.23 - compressor curve

Set whether the compressor in the heat pump should work to a particular curve under specific requirements or if it should work to predefined curves.

You can set a curve for each operation mode (heat, hot water, coolingetc.) by unticking "auto", turning the control knob until a temperature is marked and pressing OK. You can set at what temperature max- min frequencies will occur.

This menu consists of several windows (one for each operation mode). Use the navigation arrow in the top left corner to change between the windows.

Menu 5.2 - system settings

Make different system settings for your installation here, e.g. activate the connected heat pump and which accessories are installed.

Menu 5.2.2 - installed heat pump

If a heat pump is connected to the master installation, set it here.

For RC-HY40-W, you can set slave unit to be connected.

There are two ways of activating connected slaves. You can either mark the alternative in the list or use the automatic function "search installed slaves".

search installed slaves

Mark "search installed slaves" and press the OK button to automatically find connected slaves for the master heat pump.

Menu 5.2.3 – docking (RC-HY40-W only)

Enter how your system is docked regarding pipes, for example to hot water heating and heating the building.

This menu has a docking memory which means that the control system remembers how a particular reversing valve is docked and automatically enters the correct docking the next time you use the same reversing valve.

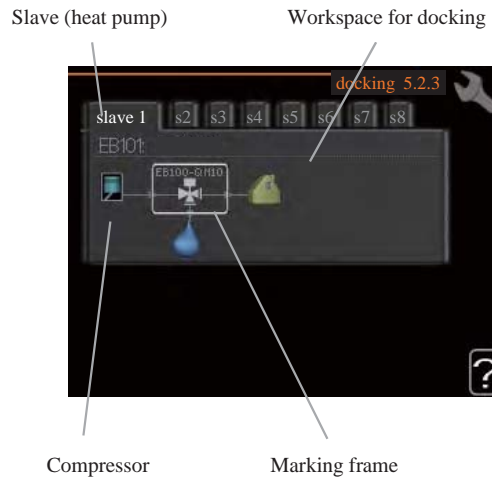







Slave: Here you select for which heat pump the docking setting is to be made.

Compressor: Select if the compressor in the heat pump is blocked (factory setting), or standard (docked for example to pool heating, hot water charging and heating the building).

Marking frame: Move around the marking frame using the control knob. Use the OK button to select what you want to change and to confirm setting in the options box that appears to the right.

Workspace for docking: The system docking is drawn here.

Symbol	Description
	Compressor (blocked)
	Compressor (standard)
	Reversing valves for hot water, cooling. The designations above the reversing valve indicate where it is electrically connected (EB101 = Slave 1, etc.).
	Hot water charging
	Heating (heating the building, includes any extra climate system)
	Cooling

Menu 5.2.4 - accessories

Set which accessories are installed on the installation here.

If the water heater is connected, hot water charging must be activated here.

Menu 5.3 - accessory settings

The operating settings for accessories that are installed and activated are made in the sub-menus for this.

Menu 5.3.2 - shunt controlled add. Heat

prioritised additional heat

Setting range: on/off

Factory setting: off

start diff additional heat

Setting range: 0 – 2000 DM

Default values: 400 DM

minimum running time

Setting range: 0 – 48 h

Default value: 12 h

min temp.

Setting range: 5 – 90 °C

Default value: 55 °C

mixing valve amplifier

Setting range: 0.1 –10.0

Default value: 1.0

mixing valve step delay

Setting range: 10 – 300 s

Default values: 30 s

Set when the addition is to start, the minimum run time and the minimum temperature for external addition with shunt here. External addition with shunt is for example a wood/oil/gas/pellet boiler.

You can set shunt valve amplification and shunt valve waiting time.

Selecting "prioritised additional heat" uses the heat from the external additional heat instead of the heat pump.

The shunt valve is regulated as long as heat is available, otherwise the shunt valve is closed.

See the accessory installation instructions for function description.

Menu 5.3.3 - extra climate system

use in heating mode

Setting range: on/off

Factory setting: on

use in cooling mode

Setting range: on/off

Factory setting: off

mixing valve amplifier

Setting range: 0.1 – 10.0

Default value: 1.0

mixing valve step delay

Setting range: 10 – 300 s

Default values: 30 s

Here you select which climate system (2 - 8) you wish to set. In the next menu you can make settings for the climate system

that you have selected. If this function is activated, you can set "cooling flow temp. at +20°C" and "cooling flow temp. at +40°C" for each climate system where the function is activated.

CAUTION

This setting option only appears if "cooling permitted" is activated in menu 5.11.1.

The shunt amplification and shunt waiting time for the different extra climate systems that are installed are also set here.

See the accessory installation instructions for function description.

Menu 5.3.4 - solar heating

Use this menu to set solar heating settings

start delta-T GP4

Setting range: 1 – 40 °C

Default value: 8 °C

stop delta-T GP4

Setting range: 0 – 40 °C

Default value: 4 °C

max. tank temperature

Setting range: 5 – 110 °C

Default value: 95 °C

max. solar collector temp.

Setting range: 80 – 200 °C

Default value: 125 °C

freeze protection

Setting range: on/off

Factory setting: off

solar panel cooling

Setting range: on/off

Factory setting: off

Menu 5.3.6 - step controlled add. heat

start addition

Setting range: 0 – 2000 DM

Default values: 400 DM

diff. between additional steps

Setting range: 0 – 1000 DM

Default values: 30 DM

max step

Setting range

(binary stepping deactivated): 0 – 3

Setting range

(binary stepping activated): 0 – 7

Default value: 3

binary stepping

Setting range: on/off

Factory setting: off

Make settings for step controlled addition here. Step controlled

addition is for example an external electric boiler.

It is possible, for example, to select when the additional heat is to start, to set the maximum number of permitted steps and whether binary stepping is to be used.

When binary stepping is deactivated (off), the settings refer to linear stepping.

See the accessory installation instructions for function description.

Menu 5.3.8 - hot water comfort

activating imm heater

Setting range: on/off

Factory setting: off

activ. imm heat in heat mode

Setting range: on/off

Factory setting: off

activating the mixing valve

Setting range: on/off

Factory setting: off

outgoing hot water

Setting range: 40 – 65 °C

Default value: 55 °C

mixing valve amplifier

Setting range: 0.1 – 10.0

Default value: 1.0

mixing valve step delay

Setting range: 10 – 300 s

Default values: 30 s

Make settings for the hot water comfort here.

See the accessory installation instructions for function description.

activating imm heater: The immersion heater is activated here if installed in the water heater.

activ. imm heat in heat mode: Activate here whether the immersion heater in the tank (required if the alternative above is activated) will be permitted to charge hot water, if the compressors in the heat pump prioritise heating.

activating the mixing valve: Activate here whether a mixer valve for limiting the temperature of hot water from the water heater is installed.

If this alternative has been activated, you can set the outgoing hot water temperature, shunt amplification and shunt waiting time for the mixer valve.

outgoing hot water: Set the temperature at which the mixing valve is to restrict hot water from the water heater.

See the accessory installation instructions for function description.

Menu 5.3.11 - modbus

word swap

Setting range: on/off

Factory setting: off

Menu 5.3.20 - flow sensor

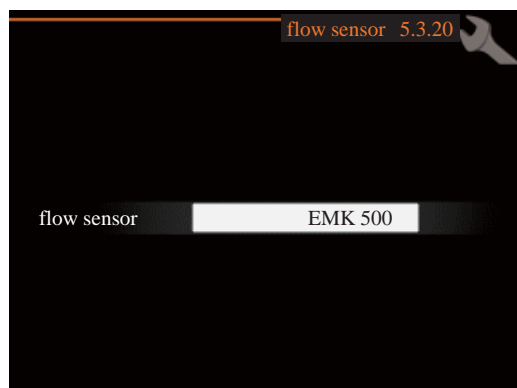

flow sensor

Setting option: EMK 500, EMK 310 / 300, EMK 150

Factory setting: EMK 500

Here you select which flow sensor is used for the energy measurement.

Menu 5.4 – soft in/outputs

You can set the function of in/output for each terminal (AUX1-6 and output).

Position of the terminal depends on the type of controller.

RC-HY20-W: port 11-18 on X2 terminal (AUX1-6), X4 terminal on AA2 board (output)

RC-HY40-W: port 9-14 on terminal X6 and port 1-4 on X2 terminal on AA3 board (AUX1-6), X7 terminal on AA3 board (output)

Menu 5.5 - factory setting service

All settings can be reset (including settings available to the user) to default values here.

NOTE

When resetting, the start guide is displayed the next time the control module is restarted.

Menu 5.6 - forced control

You can force control the different components in the control module and any connected accessories here.

Menu 5.7 - start guide

When the control module is started for the first time the start guide starts automatically. Start it manually here.

See page 42 for more information about the start guide.

Menu 5.8 - quick start

It is possible to start the compressor from here.

CAUTION

There must be a heating or hot water demand to start the compressor.

CAUTION

Do not quick start the compressor too many times over a short period of time as this may damage the compressor and its surrounding equipment.

Menu 5.9 - floor drying function

length of period 1 – 7

Setting range: 0 – 30 days

Factory setting, period 1 – 3, 5 – 7: 2 days

Factory setting, period 4: 3 days

temp. period 1 – 7

Setting range: 15 – 70 °C

Default value:

temp. period 1	20 °C
temp. period 2	30 °C
temp. period 3	40 °C
temp. period 4	45 °C
temp. period 5	40 °C
temp. period 6	30 °C
temp. period 7	20 °C

Set the function for under floor drying here.

You can set up to seven period times with different calculated flow temperatures. If less than seven periods are to be used, set the remaining period times to 0 days.

Mark the active window to activate the underfloor drying function. A counter at the bottom shows the number of days the function has been active.

TIP

If operating mode "add. heat only" is to be used, select it in menu 4.2.

Menu 5.10 - change log

Read off any previous changes to the control system here.

The date, time and ID no. (unique to certain settings) and the new set value is shown for every change.

NOTE

The change log is saved at restart and remains unchanged after factory setting.

Menu 5.11 - heat pump settings

Settings for installed heat pump can be made in the submenus.

Menu 5.11.1 - EB101 - EB108

Make settings specifically for the installed heat pump and charge pump here.

For RC-HY40-W, it is possible to connect up to 8 heat pumps.

Menu 5.11.1.1 - heat pump

Make settings for the installed heat pump here. To see what settings you can make, see installation manual for the heat pump.

Cooling permitted

Here you can set whether the cooling function is to be activated for the heat pump.

Silent mode permitted

Set whether silent mode is to be activated for the heat pump

Current limit

Set whether the current limiting function is to be activated for the heat pump here.

During active function you can limit the value of the maximum current.

Setting range: 6 - 32 A

Factory setting: 32 A

Stop temperature compressor

Here you can limit the value for the set outdoor temperature down to the value the heat pump is to work

Setting range: -20°C - -2°C

Factory setting: -20°C

blockFreq 1

Select a frequency range within the heat pump may work here

blockFreq 2

Select a frequency range within the heat pump may work here

Menu 5.11.1.2 - charge pump (GP12)

op. mode

Heating/cooling

Setting range: auto / intermittent

Default value: auto

Set the operating mode for the charge pump here.

auto: The charge pump runs according to the current operating mode for RC-HY20/40-W.

intermittent: The charge pump starts and stops 20 seconds before and after the compressor in the heat pump.

speed during operation heating, hot water, cooling

Setting range: auto / manual

Default value: auto

Manual setting

Setting range: 1 – 100 %

Default values: 70 %

speed in wait mode

Setting range: 1 – 100 %

Default values: 30 %

max. allowed speed

Setting range: 80 – 100 %

Default values: 100 %

Set the speed at which the charge pump is to operate in the present operating mode. Select "auto" if the speed of the charge pump is to be regulated automatically (factory setting) for optimal operation.

If "auto" is activated for heating operation, you can also make the setting "max. allowed speed" which restricts the charge pump and does not allow it to run at a higher speed than the set value.

For manual operation of the charge pump deactivate "auto" for the current operating mode and set the value to between 1 and 100 % (the previously set value for "max. allowed speed" no longer applies).

Speed in standby mode (only used if "auto" has been selected for "Operating mode") means the charge pump operates at the set speed during the time when there is neither a need for compressor operation nor additional heat.

5.12 - country

Select here where the product was installed. This allows access to country specific settings in your product.

Language settings can be made regardless of this selection.

NOTE

This option locks after 24 hours, restart of display or program updating.

Service

Service actions

NOTE

Servicing should only be carried out by persons with the necessary expertise.

When replacing components on the system, only genuine replacement parts may be used.

NOTE

If an electrical connection has been disconnected and is connected, ground must be checked using a suitable multimeter.

Maintenance

General inspection

Check the following:

1. Condition of casing.
2. Electrical connections.
3. Alarm log.

Correct any fault before continuing.

Climate system

Check the following:

1. Climate system start and stop temperature.
2. Heating curve settings.
3. Function of the room sensor (if installed).
4. System pressure.
5. Flow and return temperature. The difference must be 5-10 °C.

Correct any fault before continuing.

Emergency mode

NOTE

Switch (SF1) must not be put into mode "1" or Δ before the installation is filled with water.

The compressor in the heat pump can be damaged.

Emergency mode is used in event of operational interference and in conjunction with service. Hot water is not produced in emergency mode.

Emergency mode is activated by setting switch (SF1) in mode " Δ ". This means that:

- The status lamp illuminates yellow.
- The display is not lit and the control computer is not connected.
- Hot water is not produced.
- The compressors are switched off. Charge pump (EB101-GP12) is running.
- The heating medium pump is active.
- The emergency mode relay (K1) is active.

External additional heat is active if it is connected to the emergency mode relay (K1, terminal block X1).

Ensure that the heating medium circulates through the external additional heat.

Temperature sensor data

Temperature (°C)	Resistance (kOhm)	Voltage (VDC)
-40	351.0	3.256
-35	251.6	3.240
-30	182.5	3.218
-25	133.8	3.189
-20	99.22	3.150
-15	74.32	3.105
-10	56.20	3.047
-5	42.89	2.976
0	33.02	2.889
5	25.61	2.789
10	20.02	2.673
15	15.77	2.541
20	12.51	2.399
25	10.00	2.245
30	8.045	2.083
35	6.514	1.916
40	5.306	1.752
45	4.348	1.587
50	3.583	1.426
55	2.968	1.278
60	2.467	1.136
65	2.068	1.007
70	1.739	0.891
75	1.469	0.785
80	1.246	0.691
85	1.061	0.607
90	0.908	0.533
95	0.779	0.469
100	0.672	0.414

USB service outlet

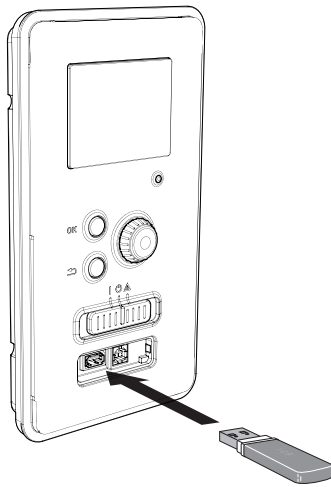

RC-HY20/40-W is equipped with a USB socket in the display unit. This USB socket can be used to connect a USB memory to update the software, save logged information and handle the settings in RC-HY20/40-W.



When a USB memory is connected a new menu (menu 7) appears in the display.

Menu 7.1 - update firmware

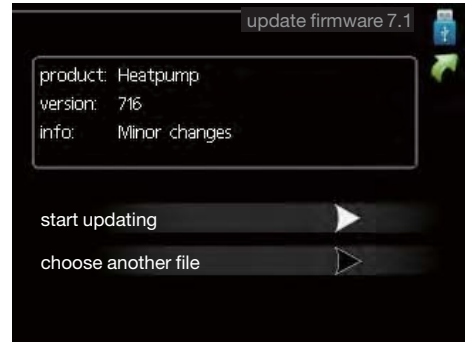

This allows you to update the software in RC-HY20/40-W.

NOTE

For the following functions to work the USB memory must contain files with software for RC-HY20/40-W.

This information states which product the software is intended for, the software version and general information about them. If you wish to select another file than the one selected, the correct file can be selected by "choose another file".

start updating

Select "start updating" if you want to start the update.

You are asked whether you really want to update the software. Respond "yes" to continue or "no" to undo.

If you responded "yes" to the previous question the update starts and you can now follow the progress of the update on the display. When the update is complete RC-HY20/40-W restarts.

NOTE

A software update does not reset the menu settings in RC-HY20/40-W

NOTE

If the update is interrupted before it is complete (for example power cut etc.) the software can be reset to the previous version if the OK button is kept pressing during start up until the green lamp starts to illuminate (takes about 10 seconds).

choose another file

Select "choose another file" if you do not want to use the suggested software. When you scroll through the files, information about the marked software is shown in a fact box just as before. When you have selected a file with the OK button you will return to the previous page (menu 7.1) where you can choose to start the update.

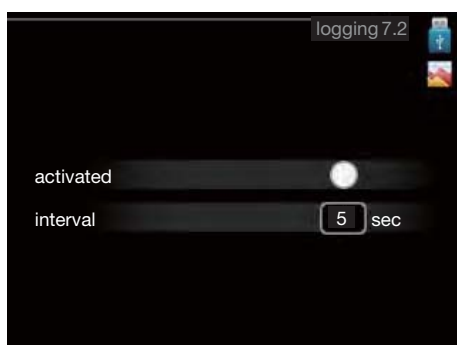
Menu 7.2 - logging

Setting range: 1 s – 60 min

Factory setting range: 5 s

You can set the interval of the log data storage and start saving the log data on the USB memory.

1. Set the desired interval between loggings.
2. Tick "activated".
3. The present values from RC-HY20/40-W are saved in a file in the USB memory at the set interval until "activated" is unticked.

NOTE

*Untick "activated" before removing the USB memory.
Menu 7.3 - manage settings*

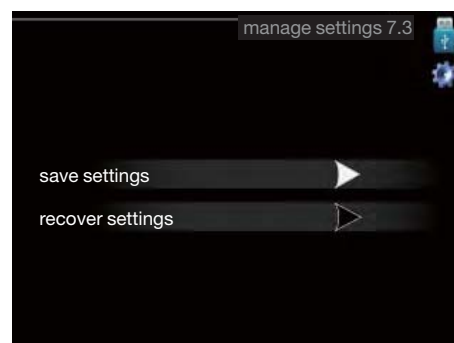
Menu 7.3 - manage settings

Here you can manage (save as or retrieve from) all the menu settings (user and service menus) in RC-HY20/40-W with a USB memory.

Via "save settings" you save the menu settings to the USB memory in order to restore them later or to copy the settings to another RC-HY20/40-W.

NOTE

When you save the menu settings to the USB memory you replace any previously saved settings on the USB memory.

Via "recover settings" you reset all menu settings from the USB memory.

NOTE

Reset of the menu settings from the USB memory cannot be undone.

Pump down operation – FDCW60VNX-W + HSB60-W

This function can only be started when operation mode is set to addition heat only on menu 4.2. :



When this operating mode is activated pump down is available on service menu 5.11.

Menu number	Setting	Alternatives	Default	Other
5.11.X.1	Pump down	Yes/No	No	Menu only displayed in "Addition heat only" mode
5.11.X.2	Start pump down	Yes/No	No	Activates compressor operation. Above menu has to set "Yes" to display this meny

Once the function has been activated:

- Compressor starts cooling operation with 2 minutes delay time
- Target compressor speed will be 56 rps
- Circulation pump runs at 100% when compressor starts

Pump down stops automatically when one of the following conditions is fulfilled:

- Pressure at BP4 gets lower more than 0.087 Mpa for more than 5 seconds
- More than 5 minutes have passed
- An alarm stops the compressor operation

When pump down is stopped:

- Circulation pump runs at it normal operation
- Pump down changes to "No"
- Start pump down changes to "No"

CAUTION

Make sure to close the service valves according to service manual for recovery of refrigerant unit!

Disturbance in comfort

In most cases, the control module notes a malfunction and indicates this with alarms and shows instructions to rectify it in the display. See "Manage alarm" for information about managing alarms. If the malfunction does not appear in the display, or if the display is not lit, the following troubleshooting guide can be used.

Manage alarm

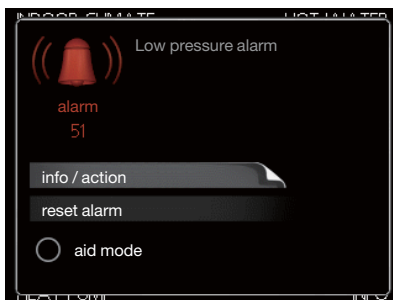

In the event of an alarm, some kind of malfunction has occurred, which is indicated by the status lamp changing from green continuously to red continuously. In addition, an alarm bell appears in the information window.

Alarm

In the event of an alarm with a red status lamp a malfunction has occurred that the heat pump and/or control module cannot remedy itself. In the display, by turning the control knob and pressing the OK button, you can see the type of alarm it is and reset it. You can also choose to set the installation to aid mode.

info / action Here you can read what the alarm means and receive tips on what you can do to correct the problem that caused the alarm.

reset alarm In most cases it is enough to select "reset alarm" to correct the problem that caused the alarm. If a green light illuminates after selecting "reset alarm" the alarm has been remedied. If a red light is still visible and a menu called "alarm" is visible in the display, the problem that caused the alarm remains. If the alarm disappears and then returns, see the troubleshooting section.

aid mode "aid mode" is a type of emergency mode. This means that the installation produces heat and/or hot water despite there being some kind of problem. This can mean that the heat pump's compressor is not running. In this case any electrical addition produces heat and/or hot water.

NOTE

To select aid mode an alarm action must be selected in the menu 5.1.4.

CAUTION

Selecting "aid mode" is not the same as correcting the problem that caused the alarm. The status lamp will therefore continue to be red.

Troubleshooting

If the operational interference is not shown in the display the following tips can be used:

Basic actions

Start by checking the following possible fault sources:

- The switch's (SF1) position.
- Group and main fuses of the accommodation.
- The property's earth circuit breaker.
- The control module's miniature circuit breaker (FA1).

Low hot water temperature or a lack of hot water

This part of the fault-tracing chapter only applies if the water heater is installed in the system.

- Closed or choked filling valve for the hot water heater.
 - Open the valve.
- Mixing valve (if there is one installed) set too low.
 - Adjust the mixer valve.
- Control module in incorrect operating mode.
 - If mode "manual" is selected, select "addition".
- Large hot water consumption.
 - Wait until the hot water has heated up. Temporarily increased hot water capacity (temporary lux) can be activated in menu 2.1.
- Too low hot water setting.
 - Enter menu 2.2 and select a higher comfort mode.
- Too low or no operating prioritisation of hot water.
 - Enter menu 4.9.1 and increase the time for when hot water is to be prioritised.

Low room temperature

- Closed thermostats in several rooms.
 - Set the thermostats to max, in as many rooms as possible. Adjust the room temperature via menu 1.1, instead of choking the thermostats.
- Control module in incorrect operating mode.
 - Enter menu 4.2. If mode "auto" is selected, select a higher value on "stop heating" in menu 4.9.2.
 - If mode "manual" is selected, select "heating". If this is not enough, select "addition".
- Too low set value on the automatic heating control.
 - Enter menu 1.1 "temperature" and adjust the offset heating curve up. If the room temperature is only low in cold weather the curve slope in menu 1.9.1 "heating curve" needs adjusting up.
- Too low or no operating prioritisation of heat.
 - Enter menu 4.9.1 and increase the time for when heating is to be prioritised.
- "Holiday mode" activated in menu 4.7.
 - Enter menu 4.7 and select "Off".

- External switch for changing the room heating activated.
 - Check any external switches.
- Air in the climate system.
 - Vent the climate system.
- Closed valves to the climate system.
 - Open the valves.
- Incorrectly adjusted flow across the heat pump.
 - Check whether alarm high condenser in (163) or high condenser out (162) is in the alarm log. Follow the instructions for adjusting charge flow.

High room temperature

- Too high set value on the automatic heating control.
 - Enter menu 1.1 (temperature) and reduce the offset heating curve. If the room temperature is only high in cold weather the curve slope in menu 1.9.1 "heating curve" needs adjusting down.
- External switch for changing the room heating activated.
 - Check any external switches.

Low system pressure

- Not enough water in the climate system.
 - Top up the water in the climate system.

The compressor does not start

- There is no heating requirement.
 - The heat pump does not call on heating nor hot water.
- Temperature conditions tripped.
 - Wait until the temperature condition has been re- set.
- Minimum time between compressor starts has not been reached.
 - Wait 30 minutes and check if the compressor has started.
- Alarm tripped.
 - Follow the display instructions.

Additional heating only

If you are unsuccessful in rectifying the fault and are unable to heat the house, you can, whilst waiting for assistance, continue running the heat pump in "add. heat only". This means that additional heating only is used to heat the house.

Set the installation to additional heat mode

1. Go to menu 4.2 op. mode.
2. Mark "add. heat only" using the control knob and then press OK button.

Return to the main menus by pressing the Back button.

CAUTION

When commissioning without MTH air/water heat pump an alarm communication error may appear in the display.

The alarm is reset if the relevant heat pump is deactivated in menu 5.2.2 ("installed heat pump").

Alarm list

In event of an alarm, the red lamp on the remote controller lights up (changes from green to red).

First go through the suggested actions shown in the display.

The alarms shown on this list apply to all range.

Alarm no.	Alarm text on the display	Cause	Indoor module/heat pump measures	May be due to
1	Sensor fault: BT1 outdoor sensor	No contact with the sensor (Temperature sensor, outdoor)	Calculated supply temp. is set to min. supply	<ul style="list-style-type: none"> ● Open circuit or short circuit on sensor input ● Defective sensor
6	Sensor fault: BT6 hot water load	No contact with the sensor (Temperature sensor, hot water charging)	Hot water charging is blocked.	<ul style="list-style-type: none"> ● Open circuit or short circuit on sensor input ● Defective sensor
25	Sensor fault: BT25 external supply	No contact with the sensor (Temperature sensor, heat medium supply, external)	Additional heat is blocked. New actual value = BT71 + 10K	<ul style="list-style-type: none"> ● Open circuit or short circuit on sensor input ● Defective sensor
28	Sensor fault: BT71 external return sensor	No contact with the sensor (Temperature sensor, return line, external)	No action but heating is blocked if alarm 25 occurs at the same time.	<ul style="list-style-type: none"> ● Open circuit or short circuit on sensor input ● Defective sensor
31	Sensor error: BT63 flow sensor	No contact with the sensor (Temperature sensor, external supply line after heater)	Additional heat is blocked if the additional heat is before the reversing valve.	<ul style="list-style-type: none"> ● Open circuit or short circuit on sensor input ● Defective sensor
33	Sensor fct: BT53 solar panel	Sensor not connected/defective (solar panel)	Switches off solar function.	<ul style="list-style-type: none"> ● Open circuit or short circuit on sensor input ● Defective sensor
34	Sensor fct: BT54 solar	Sensor not connected/defective (solar coil)	Switches off solar function.	<ul style="list-style-type: none"> ● Open circuit or short circuit on sensor input ● Defective sensor
35	Sensor fct: BT52 boiler sensor	No contact with the sensor (Temperature sensor, boiler)	Shunt closes. Burner (boiler) is stopped.	<ul style="list-style-type: none"> ● Open circuit or short circuit on sensor input ● Defective sensor
36	Sensor fct: EP21 BT2 flow line sensor	Sensor not connected/defective (supply temperature sensor extra climate system 2)	Controls the return line sensor (EP21-BT3)	<ul style="list-style-type: none"> ● Open circuit or short circuit on sensor input ● Defective sensor
37	Sensor fct: EP22 BT2 flow line sensor	Sensor not connected/defective (supply temperature sensor extra climate system 3)	Controls the return line sensor (EP22-BT3)	<ul style="list-style-type: none"> ● Open circuit or short circuit on sensor input ● Defective sensor
38	Sensor fct: EP23 BT2 flow line sensor	Sensor not connected/defective (supply temperature sensor extra climate system 4)	Controls the return line sensor (EP23-BT3)	<ul style="list-style-type: none"> ● Open circuit or short circuit on sensor input ● Defective sensor
39	Sensor error: EQ1-BT64 cooling supply	No contact with the sensor (Temperature sensor, cooling supply line)	Cooling is blocked. Cooling shunt closes.	<ul style="list-style-type: none"> ● Open circuit or short circuit on sensor input ● Defective sensor
48	Sens fct room sens cool oper	No contact with the sensor, cooling)	Cooling operation is blocked. Manual reset when the sensor has contact.	<ul style="list-style-type: none"> ● Open circuit or short circuit on sensor input ● Defective sensor
56	Erroneous serial no	The heat pump has a serial number that does not exist	Compressors are stopped and relay is deactivated	Incorrectly entered serial number.
57	Erroneous software	The heat pump's program and serial number do not match each other	Compressors are stopped and relay is deactivated	Incorrect software installed.

Alarm no.	Alarm text on the display	Cause	Indoor module/heat pump measures	May be due to
70	Communication fault with PCA input	Communication with the input board (AA3) is missing	Calculated supply temperature is set to min. supply temperature	Defective communication cables
71	Communication fault with PCA base	Communication with PCB (AA2) is missing	Compressor is blocked.	Defective communication cables
73-91	Com. err. PCA Accessory	Communication with the accessory board is missing.	Accessory is blocked.	<ul style="list-style-type: none"> ● Defective communication cables ● The accessory is activated in the display while not connected to the communication cable ● Incorrectly connected communication cable ● Incorrectly set DIP switch ● No electrical supply to the accessory board
96-99	Com. err. RMU	Communication with the room unit is missing.	The room unit is blocked	Defective communication cables
130-135	Com. flt PCA accessory	The communication with the accessory board for climate systems 5-8 has been missing for 15 seconds.	Accessory is blocked	<ul style="list-style-type: none"> ● Defective communication cables ● The accessory is activated in the display while not connected to the communication cable ● Incorrectly connected communication cable ● Incorrectly set DIP switch ● No electrical supply to the accessory board
156	Low lp cool	5 repeated alarms for low-pressure within 4 hours	Compressor is blocked. Manual reset	<ul style="list-style-type: none"> ● Poor flow ● Significant wind effect
193	Com. flt PCA accessory	Communication fault to EME20M has occurred 3 times in a row.	Accessory is blocked. Automatic reset once there has been communication for 60 seconds.	<ul style="list-style-type: none"> ● Defective communication cables ● The accessory is activated in the display while not connected to the communication cable ● Incorrectly connected communication cable ● Incorrectly set DIP switch ● No electrical supply to the accessory board
206	Com. flt PCA accessory	Communication with the accessory board for HW comfort has been missing for 15 seconds.	Accessory is blocked	<ul style="list-style-type: none"> ● Defective communication cables ● The accessory is activated in the display while not connected to the communication cable ● Incorrectly connected communication cable ● Incorrectly set DIP switch ● No electrical supply to the accessory board

Disturbance in comfort

Alarm no.	Alarm text on the display	Cause	Indoor module/heat pump measures	May be due to
208	Com. flt PCA accessory	Communication with the accessory board for external additional heat has been missing for 15 seconds	Switches off step-controlled additional heat	<ul style="list-style-type: none"> ● Defective communication cables ● The accessory is activated in the display while not connected to the communication cable ● Incorrectly connected communication cable ● Incorrectly set DIP switch ● No electrical supply to the accessory board
212	Cmpr has not been running for a week	Compressor has not been running for a week	According to selected measure in the menu	Check settings
218	The compressor's rotor is blocked.		Compressor is blocked	Defective compressor
220	High pressure alarm	The high pressure switch (63H1) has deployed 5 times within 60 minutes or has been deployed for 60 minutes continuously.	Compressor is blocked	<ul style="list-style-type: none"> ● Insufficient air circulation of blocked heat exchanger ● Open circuit or short circuit on input for high pressure switch (63H1) ● Defective high pressure switch ● The expansion valve is not connected correctly ● Service valve closed ● Defective control board in outdoor unit ● Low or no flow during heating operation ● Defective circulation pump ● Defective fuse F(4A)
221	Low pressure alarm	To low value on the low pressure sensor 3 times within 60 minutes	Compressor is blocked	<ul style="list-style-type: none"> ● Open circuit or short circuit on input for low pressure sensor ● Defective low pressure sensor ● Defective control board in outdoor unit ● Open circuit or short circuit on input for suction gas sensor (Tho-S)
223	Motor protection alarm	Communication between the control board and the communication board is interrupted. There must be 22 VDC at the switch CNW2 on the control board (PWB1)	Compressor is blocked	<ul style="list-style-type: none"> ● Any circuit breakers for the outdoor unit are in the off position ● Incorrect cable routing
224	Fan alarm from heat pump	Deviations in the fan speed in the outdoor unit	Compressor is blocked	<ul style="list-style-type: none"> ● Fan blocked or not connected ● Defective fan motor ● Fuse blown
225	Mixing up sensor flow/return	The return is hotter than the supply	Compressor is blocked	The connection for the supply and the return is mixed up.
227	Sensor fault from heat pump	Sensor not connected/defective	Compressor is blocked	Open circuit or short circuit on sensor input

Alarm no.	Alarm text on the display	Cause	Indoor module/heat pump measures	May be due to
228	Failed defrosting	Failed 10 consecutive defrostings	Compressor is blocked	<ul style="list-style-type: none"> • System temperature too low and/or poor flow • Insufficient available system volume • Significant wind effect • Clogged particle filter
229	Short operating times for compr.	Operation was stopped from the indoor unit section after less than 5 minutes	Compressor is blocked	<ul style="list-style-type: none"> • Poor flow or poor heat transfer • Incorrect settings for heating and/or hot water
230	Hot gas alarm	Temperature deviations on the discharge sensor. Alarm 2 times within 60 minutes or continuous alarm for 60 minutes	Compressor is blocked	<ul style="list-style-type: none"> • Disruption in the refrigerant circuit • Lack of refrigerant
232	Low evaporation temp	5 repeated alarms for low evaporation temperature within 4 hours	Compressor is blocked	<ul style="list-style-type: none"> • Lack of refrigerant • Blocked expansion valve • Significant wind effect
251	Com. err. MODBUS	Communication error with the accessory (MODBUS40M) has been missing for 15 seconds	The accessory is blocked. Manual reset	Check the communication
261	High HWX temp	Temperature deviation on the heat exchanger sensor (ThoR1/R2) 5 times within 60 minutes or continuously for 60 minutes.	Compressor is blocked	<ul style="list-style-type: none"> • Defective sensor • Insufficient air circulation or blocked heat exchanger • Defective control board in FDCW • Too much refrigerant
262	Inv. err.	Power transistor too hot. When IPM (Intelligent Power Module) show FO (Fault output) signal 5 times for 60 minutes.	Compressor is blocked	The 15V supply to the inverter is unstable
263	Inv. err.	Voltage from the inverter outside the parameters 4 times within 30 minutes	Compressor is blocked	<ul style="list-style-type: none"> • Incoming power supply interference • Service valve closed • Insufficient amount of refrigerant • Compressor fault • Defective inverter board in FDCW
264	Communication error with inverter	Communication between inverter board and control board/PCB interrupted	Compressor is blocked	<ul style="list-style-type: none"> • Poor connection between control board/PCB and inverter • Inverter de-energised or defective • Defective control board in FDCW
265	Inv. err.	Continuous deviation on power transistor for 15 minutes	Compressor is blocked	<ul style="list-style-type: none"> • Defective fan motor • Defective circuit board in FDCW
266	Low refig.	Insufficient refrigerant has been detected at start-up in cooling operation. 1 minute after start-up, BT15 must have decreased 15K compared to BT3.	Compressor is blocked	<ul style="list-style-type: none"> • Service valve closed • Loose connection on sensor (BT15, BT3) • Defective sensor (BT15, BT3)

Disturbance in comfort

Alarm no.	Alarm text on the display	Cause	Indoor module/heat pump measures	May be due to
267	Inv. err	Failed start for compressor	Compressor is blocked	<ul style="list-style-type: none"> Defective circuit board for inverter in FDCW Defective control board in FDCW Compressor fault
268	Inv. err.	Overcurrent, inverter A/F module	Compressor is blocked	Sudden power failure
277	Sensor fault from heat pump	The input for the sensor Tho-R (evaporator sensor) has received an unreasonably high or low value 3 times within 40 minutes	Compressor is blocked	<ul style="list-style-type: none"> Open circuit or short circuit on sensor input Defective sensor
278	Sensor fault from heat pump	The input for the sensor Tho-A (outdoor sensor) has received an unreasonably high or low value 3 times within 40 minutes	Compressor is blocked	<ul style="list-style-type: none"> Open circuit or short circuit on sensor input Defective sensor
279	Sensor fault from heat pump	The input for the sensor Tho-D (discharge sensor) has received an unreasonably high or low value 3 times within 40 minutes	Compressor is blocked	<ul style="list-style-type: none"> Open circuit or short circuit on sensor input Defective sensor
280	Sensor fault from heat pump	The input for the sensor Tho-S (suction gas sensor) has received an unreasonably high or low value 3 times within 40 minutes	Compressor is blocked	<ul style="list-style-type: none"> Open circuit or short circuit on sensor input Defective sensor
281	Sensor fault from heat pump	The input for the sensor LPT (low pressure sensor) has received an unreasonably high or low value 3 times within 40 minutes	Compressor is blocked	<ul style="list-style-type: none"> Open circuit or short circuit on sensor input Defective sensor
282	Com. flt PCA accessory	Temporary comm. fault 4 pipe active cooling	Accessory is blocked	<ul style="list-style-type: none"> Defective communication cables Incorrectly set DIP switch The accessory is activated in the display, but is not connected with a communication cable Incorrectly connected communication cable No electrical supply to the accessory board
292	Sen flt: BT74 cool/heat sensor	Sensor BT74 on the AUX input is not connected/defective	According to selected measure in the menu	<ul style="list-style-type: none"> Open circuit or short circuit on sensor input Defective sensor
294	Incompatible heat pump	The outdoor air heat pump is not compatible	Compressor is blocked	<ul style="list-style-type: none"> Upgrade of outdoor unit failed No software in outdoor unit
301	Slave heat pump #1 comm. err.	Communication with slave heat pump 1 has been missing for 15 seconds	Blocking compressor in heat pump 1	Check communication cables
302-308	Comm. err. slave 2-8	Communication with slave heat pump 2-8 has been missing for 15 seconds	Blocking compressor in heat pump 2-8	Check communication cables

Alarm no.	Alarm text on the display	Cause	Indoor module/heat pump measures	May be due to
319	Comm.flt. with EB103/4 -GP12	Communication with the accessory board for GP12 has been missing for 15 seconds	Blocking relevant compressor and stopping relevant GP12	<ul style="list-style-type: none"> ● Defective communication cables ● Incorrectly set DIP switch ● The accessory is activated in the display, but is not connected with a communication cable ● Incorrectly connected communication cable ● No electrical supply to the accessory board
320	Comm.flt. with EB105/6 -GP12	Communication with the accessory board for GP12 has been missing for 15 seconds	Blocking relevant compressor and stopping relevant GP12	<ul style="list-style-type: none"> ● Defective communication cables ● Incorrectly set DIP switch ● The accessory is activated in the display, but is not connected with a communication cable ● Incorrectly connected communication cable ● No electrical supply to the accessory board
321	Comm.flt. with EB107/8 -GP12	Communication with the accessory board for GP12 has been missing for 15 seconds	Blocking relevant compressor and stopping relevant GP12	<ul style="list-style-type: none"> ● Defective communication cables ● Incorrectly set DIP switch ● The accessory is activated in the display, but is not connected with a communication cable ● Incorrectly connected communication cable ● No electrical supply to the accessory board
336	Sen flt: EP44 BT2 supply temp sens.	Sensor not connected/defective	The sensor signal is replaced by EP44-BT3 - 10K during shunt control	<ul style="list-style-type: none"> ● Open circuit or short circuit on sensor input ● Defective sensor
337	Sen flt: EP45 BT2 supply temp sens.	Sensor not connected/defective	The sensor signal is replaced by EP45-BT3 - 10K during shunt control	<ul style="list-style-type: none"> ● Open circuit or short circuit on sensor input ● Defective sensor
338	Sen flt: EP46 BT2 supply temp sens.	Sensor not connected/defective	The sensor signal is replaced by EP46-BT3 - 10K during shunt control	<ul style="list-style-type: none"> ● Open circuit or short circuit on sensor input ● Defective sensor
339	Sen flt: EP47 BT2 supply temp sens.	Sensor not connected/defective	The sensor signal is replaced by EP47-BT3 - 10K during shunt control	<ul style="list-style-type: none"> ● Open circuit or short circuit on sensor input ● Defective sensor
341	Recurring safety defr.	Alarm from outdoor unit	Compressor is blocked	Check whether the outdoor unit has iced up and check the sensor
344	Recurring low pressure	Alarm from outdoor unit	Compressor is blocked	
346	Recurring high pressure	Alarm from outdoor unit	Compressor is blocked	
372	Perm. com. error pool 2	Communication with Pool 2 has been missing for 15 seconds	Accessory is blocked	Defective communication cables

Disturbance in comfort

Alarm no.	Alarm text on the display	Cause	Indoor module/heat pump measures	May be due to
400	Unspecified fault	Unspecified faults	Master is blocking relevant compressor and frost protection is safeguarded	The outdoor unit software could be more recent than the indoor unit's alarm.
403	Sensor fault from PCA 154	Sensor fault in the outdoor unit	Compressor is blocked	Check the temperature sensors and its connections
404	Sensor fault from PCA 154	Sensor fault in the outdoor unit	Compressor is blocked	Check the temperature sensors and its connections
412	Sensor fault from PCA 154	Sensor fault in the outdoor unit	Compressor is blocked	Check the temperature sensors and its connections
415	Sensor fault from PCA 154	Sensor fault in the outdoor unit	Compressor is blocked	Check the temperature sensors and its connections
421	Com. fault w. inverter	A temporary communication alarm has occurred 3 times within 2 hours or has been active for 1 hour	Compressor is blocked Manual reset	
425	Triggered pressure switch	Permanent pressure switch alarm	Compressor is blocked	<ul style="list-style-type: none"> • Check the heating medium flow • Lack of refrigerant
427	Safety stop inverter	A temporary fault in the inverter has occurred 2 times within 60 minutes	Compressor is blocked	Main and group fuses and their cable connections
429	Safety stop inverter	A temporary internal fault in the inverter has occurred 3 times within 2 hours	Compressor is blocked	Main and group fuses and their cable connections
431	High mains voltage	The phase voltage in the inverter has been too high 3 times within 3 hours or continuously for 1 hour	Compressor is blocked	Main and group fuses and their cable connections
433	Inverter alarm type I	The phase voltage in the inverter has been too low 3 times within 3 hours or continuously for 1 hour	Compressor is blocked	<ul style="list-style-type: none"> • Main and group fuses and their cable connections • Low supply voltage • Phase loss
437	Mains disturbance	A temporary fault has occurred 3 times within 2 hours or has been continuous for 1 hour	Compressor is blocked	<ul style="list-style-type: none"> • Main and group fuses and their cable connections • Incorrect connection in the inverter terminal block X5
439	Overheated inverter	The inverter has temporarily reached max working temperature due to poor cooling 3 times within 2 hours or continuously for 1 hour	Compressor is blocked	<ul style="list-style-type: none"> • Poor position of inverter - check screws and paste • Defective inverter
441	Inverter alarm type II	Max current in has been temporarily too high 3 times within 2 hours or continuously for 1 hour	Compressor is blocked	<ul style="list-style-type: none"> • Main and group fuses and their cable connections • Too high current to inverter • Low supply voltage
443	Overheated inverter	The inverter has temporarily reached max working temperature due to poor cooling 3 times within 2 hours or continuously for 1 hour	Compressor is blocked	<ul style="list-style-type: none"> • Poor position of inverter - check screws and paste • Defective inverter

Alarm no.	Alarm text on the display	Cause	Indoor module/heat pump measures	May be due to
445	Inverter protection	The inverter detected a temporary fault within 10 seconds after compressor start, 5 times in a row	Compressor is blocked	<ul style="list-style-type: none"> • Main and group fuses and their cable connections • Defective compressor
447	Phase drop	Compressor phase has been missing 3 times within 2 hours or continuously for 1 hour	Compressor is blocked	<ul style="list-style-type: none"> • Main and group fuses and their cable connections • Incorrectly connected compressor cable
449	Failed compressor starts	The compressor has not started when required 3 times within 2 hours	Compressor is blocked	<ul style="list-style-type: none"> • Defective inverter • Defective compressor
453	High curr load cmpr	The output current from the inverter to the compressor has been temporarily too high 3 times within 2 hours or continuously for 1 hour	Compressor is blocked	<ul style="list-style-type: none"> • Main and group fuses and their connections • Internal compressor wiring - if compressor is running slowly. If not replace inverter
455	High power load compressor	The power output from the inverter has been too high 3 times within 2 hours or continuously for 1 hour	Compressor is blocked	<ul style="list-style-type: none"> • Main and group fuses and their cable connections • Internal compressor wiring, inverter • Compressor
461	Inverter alarm type II	The current to the inverter has been too high 3 times within 2 hours or continuously for 1 hour	Compressor is blocked	<ul style="list-style-type: none"> • Main and group fuses and their cable connections • Low incoming voltage that is lower than 198 VAC
503	Compressor speed too low	The compressor speed is below the lowest permitted speed	Stops compressor	The inverter's safety function reduces the speed outside of the compressor's working range
505	Inverter has earth fault	Inverter has earth fault	Automatic reset, once no active earth fault has been sent for 60 seconds	Check connections
510	The inverter has high DC voltage	The inverter has high DC voltage	Automatic reset, when no active fault has been sent for 60 seconds	Check incoming voltage from the panels

Information messages

In event of an information message, the green light lights up on the front and symbol with a service technician is displayed in the information window, until the message is reset.

All information messages are automatically reset, if the cause is rectified. These messages are not registered in the alarm log.

Alarm no.	Alarm text on the display	Cause	Indoor module/heat pump measures	May be due to
59	Incompatible setting	Additional heat before QN10 without hot water being selected		Check the setting in menu 5.1.12
107	Sensor fct: BT7 HW sens top	The input for the sensor receives an unreasonably high or low value for longer than 2 seconds		<ul style="list-style-type: none"> ● Sensor not connected ● Open circuit or defective sensor
151	Sen fct: CL11-BT51	The input for the sensor receives an unreasonably high or low value for longer than 5 seconds	Pool pump stops	<ul style="list-style-type: none"> ● Sensor not connected ● Open circuit or defective sensor
152	Sen fct: CL12-BT51	The input for the sensor receives an unreasonably high or low value for longer than 5 seconds	Pool pump stops	<ul style="list-style-type: none"> ● Sensor not connected ● Open circuit or defective sensor
157	Low lp cool	The low pressure transmitter in the outdoor unit is showing a value too low	Compressor is blocked	<ul style="list-style-type: none"> ● Poor flow ● Significant wind effect
162	High condenser out temperature	Condenser out has reached max permitted temperature	Compressor is blocked	<ul style="list-style-type: none"> ● Incorrectly set heating curve ● Low heating medium flow ● Undersized heating system
163	High condenser in temperature	Condenser in has reached max permitted temperature	Compressor is blocked	<ul style="list-style-type: none"> ● Incorrectly set heating curve ● Low heating medium flow ● Undersized heating system
170	Communication fault with PCA input	Communication fault has occurred to the input board AA3	None	Check the communication cables and their connections
171	Communication fault with PCA base	A temporary communication fault has occurred to PCB AA2	Compressor is blocked	Check the communication cables and their connections
173-178	Com. err. acc.	Communication fault has occurred to the accessory board	Accessory is blocked	<ul style="list-style-type: none"> ● Defective communication cables ● The accessory is activated in the display while not connected to the communication cable ● Incorrectly connected communication cable ● Incorrectly set DIP switch ● No electrical supply to the accessory board

Alarm no.	Alarm text on the display	Cause	Indoor module/heat pump measures	May be due to
180	Anti-freeze	Frost protection active. Occurs when the outdoor temperature is below 3°C and no heating is permitted, and when the supply temperature sensor has an actual value that is below the calculated supply temperature (usually min. supply temperature)	Heating is permitted and compressor is permitted if there is no alarm blocking the compressor. Additional heat is permitted if there is no alarm blocking the additional heat. Calculated supply temperature is set to min. supply temperature	Incorrect settings
181	Problems at periodic increasing	Periodic hot water increase did not reach the stop temperature in 5 hours	Only information	Incorrect settings
182	Load monitor active	Measured power consumption for at least one phase exceeds the fuse size that has been specified in menu 5.1.12	The heat pump disconnects the power steps for the electric additional heat step by step	<ul style="list-style-type: none"> ● Phase loading ● A larger main fuse may be needed
183	Defrosting	Defrosting in progress	Information only, no action	
187	Com. err. acc.	Communication fault has occurred Step controlled additional heat	Accessory is blocked	<ul style="list-style-type: none"> ● Defective communication cables ● The accessory is activated in the display while not connected to the communication cable ● Incorrectly connected communication cable ● Incorrectly set DIP switch ● No electrical supply to the accessory board
188	Com. err. PCA accessory	Communication fault has occurred Solar heating	Accessory is blocked	<ul style="list-style-type: none"> ● Defective communication cables ● The accessory is activated in the display while not connected to the communication cable ● Incorrectly connected communication cable ● Incorrectly set DIP switch ● No electrical supply to the accessory board
191	Com. err. PCA accessory	Communication fault has occurred Hot water comfort	Accessory is blocked	<ul style="list-style-type: none"> ● Defective communication cables ● The accessory is activated in the display while not connected to the communication cable ● Incorrectly connected communication cable ● Incorrectly set DIP switch ● No electrical supply to the accessory board

Disturbance in comfort

Alarm no.	Alarm text on the display	Cause	Indoor module/heat pump measures	May be due to
209	Com. flt PCA accessory	Communication fault has occurred Step controlled additional heat	Shuts down step controlled additional heat	<ul style="list-style-type: none"> ● Defective communication cables ● The accessory is activated in the display while not connected to the communication cable ● Incorrectly connected communication cable ● Incorrectly set DIP switch ● No electrical supply to the accessory board
211	Cpr not running	The compressor has not been running for 36 hours even if needed		Check settings
226	Stove monitor activated	Stove monitor activated	Only information	
270	Compr. preheat in progress	Preheating of compressor in progress	Compressor is blocked	Start-up in cold weather
271	Cold outd air, heating mode	The outside temperature is outside the outdoor unit's working range	Compressor is blocked	See technical specifications in the relevant manual
272	Warm outd air, heat. mode	The outdoor temperature is outside the outdoor unit's working range	Compressor is blocked	See technical specifications in the relevant manual
273	Short run times twice in a row	Set hot water levels cannot be reached	HW-start and HW-stop for economy and normal are set to factory default	Incorrectly set values
274	Compressor limited by load monitor	The load monitor prevents the compressor from running at desired power	None	Main fuse too small
275	Compressor long term. restr. by load monitor	The load monitor prevents the compressor from running at desired power	None	Main fuse too small
282	Com. flt PCA Accessory	Communication fault has occurred Active cooling 4 pipe	Accessory is blocked	<ul style="list-style-type: none"> ● Defective communication cables ● The accessory is activated in the display while not connected to the communication cable ● Incorrectly connected communication cable ● Incorrectly set DIP switch ● No electrical supply to the accessory board
334	Max. incoming temp. exceeded	The maximum temperature through the unit exceeded. BT3 is higher than 65°C in heating mode	Heating prioritisation is blocked	<ul style="list-style-type: none"> ● Undersized heating system ● Incorrect heating curve ● Flow related ● Additional heat incorrectly connected
342	Low water temperature in	Low temperature in during cooling operation	Temporarily stops the compressor	<ul style="list-style-type: none"> ● Flow related ● Incorrect settings
343	Low temp water out	Low temperature out during cooling operation	Temporarily stops the compressor	<ul style="list-style-type: none"> ● Flow related ● Incorrect settings

Alarm no.	Alarm text on the display	Cause	Indoor module/heat pump measures	May be due to
349	Sens flt: EQ1-BT50	The cooling accessory room sensor has no contact with the control module	Parallel displacement with room sensor BT50 is set to 0	<ul style="list-style-type: none"> • Sensor not connected • Open circuit or defective sensor
350	Sensor fault on BT50 room sensor	Sensor not connected/defective	-	<ul style="list-style-type: none"> • Sensor not connected • Open circuit or defective sensor
354	Failed sensor calibration	Delta BT3-BT12 is greater than 2K after calibration	Changes from auto to manual pump speed	Flow related
355	Failed sensor calibration	Delta BT3-BT12 is larger than 2K after calibration	Changes from auto to manual pump speed	Flow related
361-368	Sensor fault EPxx, BT3 return line sensor	Sensor BT3 (return) is not connected/defective in one of the climate systems		<ul style="list-style-type: none"> • Sensor not connected • Open circuit or defective sensor
418	Low temp water out	Flow protection defrosting	Defrosting is stopped	Flow related
419	Freeze prot. exch. defr.	Frost protection exchanger defrosting	Defrosting is stopped	Flow related
420	Temp. com. fault w. inverter	A temporary communication fault in the inverter has occurred	The compressor is stopped. The compressor makes a new attempt to start 60 seconds after inverter fault has been reset	<ul style="list-style-type: none"> • Main and group fuses, as well as cable to the inverter and its connections • Check the communication cable between PCB and inverter
422	Inverter alarm type II	Compressor stop due to protection mode	Stops the compressor and makes a new start attempt soon	
424	Triggered pressure switch	Temporarily triggered pressure switch	Stops the compressor	<ul style="list-style-type: none"> • Poor heating medium flow • Lack of refrigerant
426	Temp. safety stop inv.	A temporary internal fault in the inverter has occurred.	Stops the compressor	Disruption in supply voltage
428	Temp. safety stop inv.	A temporary internal fault in the inverter has occurred	Stops the compressor	Disruption in supply voltage
430	Temp. high mains voltage	Phase voltage to the inverter too high	Stops the compressor	Disruption in supply voltage
432	Inverter alarm type I	Phase voltage to inverter too low	Stops the compressor	<ul style="list-style-type: none"> • Low supply voltage • Phase failure
436	Temp. mains disturb.	A temporary inverter fault has occurred	Stops the compressor	Disruption in voltage
438	Temp. overheated inverter	The inverter has temporarily reached max working temperature due to poor cooling	Stops the compressor	<ul style="list-style-type: none"> • Poor cooling of inverter • Defective inverter
440	Inverter alarm type II	Max. current in has been temporarily too high	Stops the compressor	<ul style="list-style-type: none"> • Poor cooling of inverter • Defective inverter
442	Temp. overheated inverter	Temporarily overheated inverter	Stops the compressor	<ul style="list-style-type: none"> • Poor cooling of inverter • Low supply voltage
444	Temp. inverter protection	The inverter detects a temporary fault	Stops the compressor	<ul style="list-style-type: none"> • Disruption in supply voltage • Defective compressor

Disturbance in comfort

Alarm no.	Alarm text on the display	Cause	Indoor module/heat pump measures	May be due to
446	Temp. phase drop	Compressor phase missing	Stops the compressor	<ul style="list-style-type: none"> ● Disruption in supply voltage ● Poor heating medium flow ● Defective compressor
448	Failed compressor start	Compressor does not start when required	Stops the compressor	<ul style="list-style-type: none"> ● Defective inverter ● Defective compressor
452	Temp. high curr load cmpr	The current out from the inverter to the compressor has been too high	Stops the compressor	<ul style="list-style-type: none"> ● Disruption in supply voltage ● Poor heating medium flow ● Defective compressor
454	Temp high pow load cmpr	Power from inverter too high	Stops the compressor	<ul style="list-style-type: none"> ● Disruption in supply voltage ● Poor heating medium flow ● Defective compressor
460	Inverter alarm type II	Current into the inverter temporarily too high	Stops the compressor	Low incoming voltage that is lower than 198 VAC
502	Compressor speed too low	Compressor speed below the lowest permitted speed	Stops the compressor	The inverter's safety function reduces the speed outside of the compressor's working range
506	Mains voltage outside inv. work. range	The mains frequency has been outside of the inverter's working range	Only information	Check the mains network
507	Mains voltage outside inv. work. range	The mains frequency has lost contact with the mains network	Only information	Check the mains network
508	Inv. lost contact with the mains	The inverter has lost contact with the mains network.	Only information	Check the connection and fuses
509	High ambient temp. at inverter	Ambient temperature at the inverter is too high	Only information	Check the location and ventilation of the inverter
523	Low flow defrosting	Low flow during defrosting	Defrosting stops	Check particle filter and circulation pump
572-575	Sensor fault in BT50 room sensor	Sensor fault BT50 in RMU 1-4	Parallel displacement with room sensor BT50 is set to 0	<ul style="list-style-type: none"> ● Sensor not connected ● Open circuit or defective sensor
580	Cold outd air, cooling mode	The outdoor temperature at the outdoor unit is outside its working range	Compressor is blocked	<ul style="list-style-type: none"> ● Outdoor temperature too low ● Defective sensor BT28 (Tho-A)
581	Warm outd air, cool. mode	The outdoor temperature at the outdoor unit is outside its working range	Compressor is blocked	<ul style="list-style-type: none"> ● Outdoor temperature too low ● Defective sensor BT28 (Tho-A)
582-588	Low flow defrosting	Low flow during defrosting in one of EB102-EB108	Defrosting stops	<ul style="list-style-type: none"> ● Flow related ● Clogged particle filter ● Defective circulation pump
900	Country not selected	Country not defined		Select country in menu 5.12 or in the start guide
995	External alarm	An alarm has occurred according to selected function on AUX input	None	External equipment connected to AUX gives an alarm
996	Blocked	Additional heat external blocked	Additional heat is blocked	External equipment connected to AUX input gives an alarm
997	Blocked	The compressor is externally blocked	Compressor is blocked	External equipment connected to AUX input gives an alarm

Alarm no.	Alarm text on the display	Cause	Indoor module/heat pump measures	May be due to
998	Starts	Display/installation has restarted		Disruption in supply voltage

Accessories

Please refer to technical manuals.

Technical data

Electric circuit diagram - HSB60/100-W

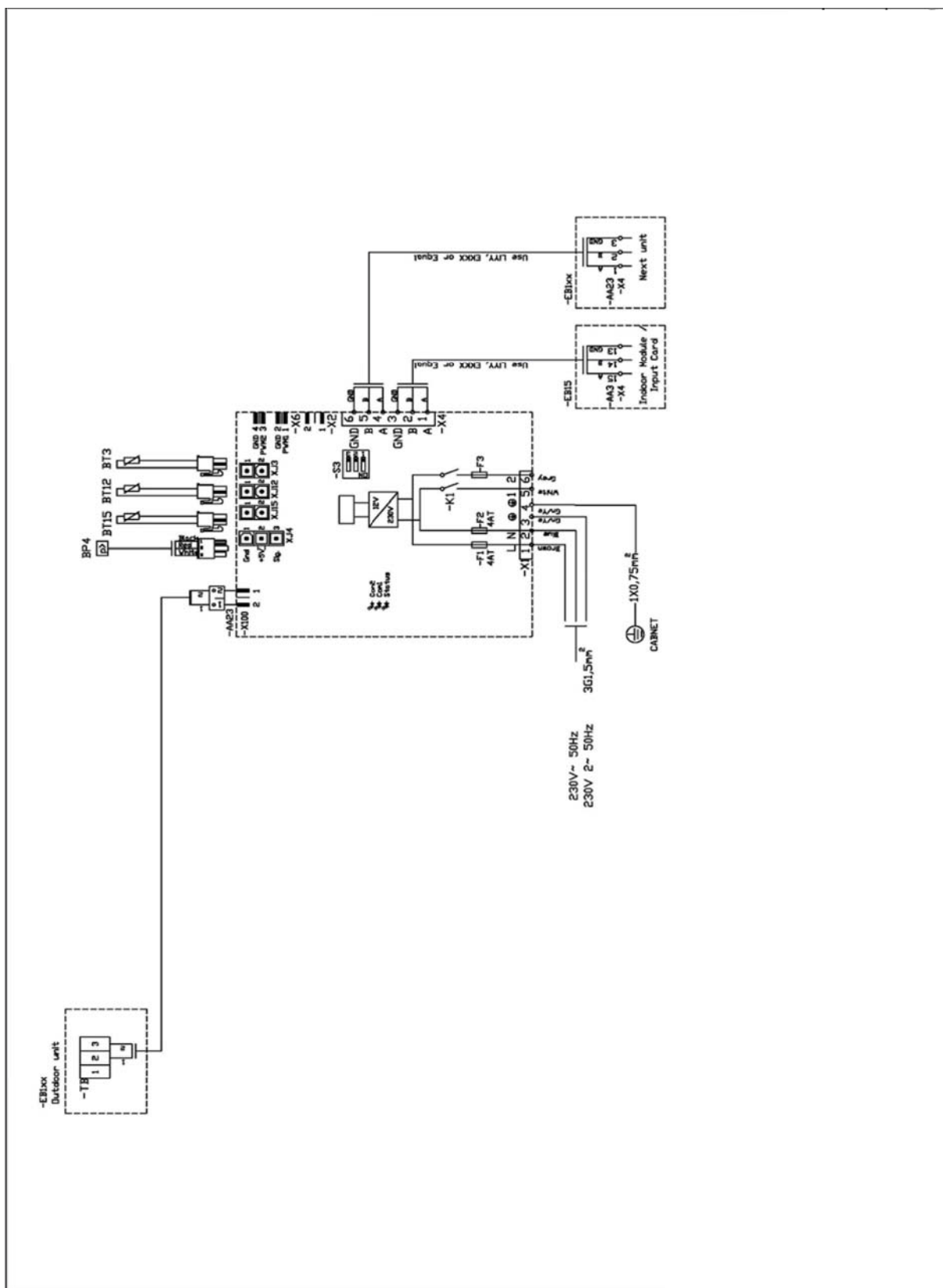

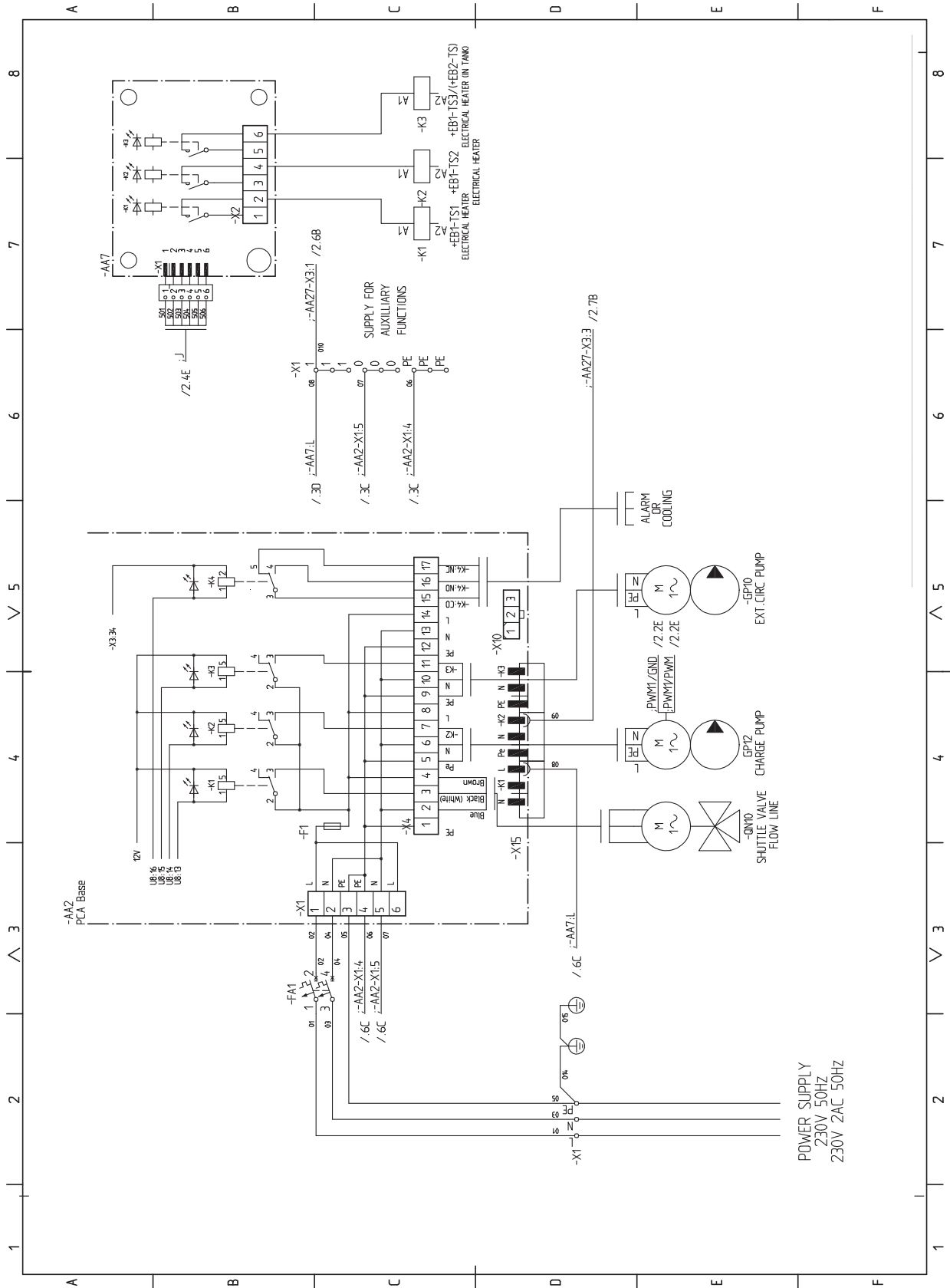

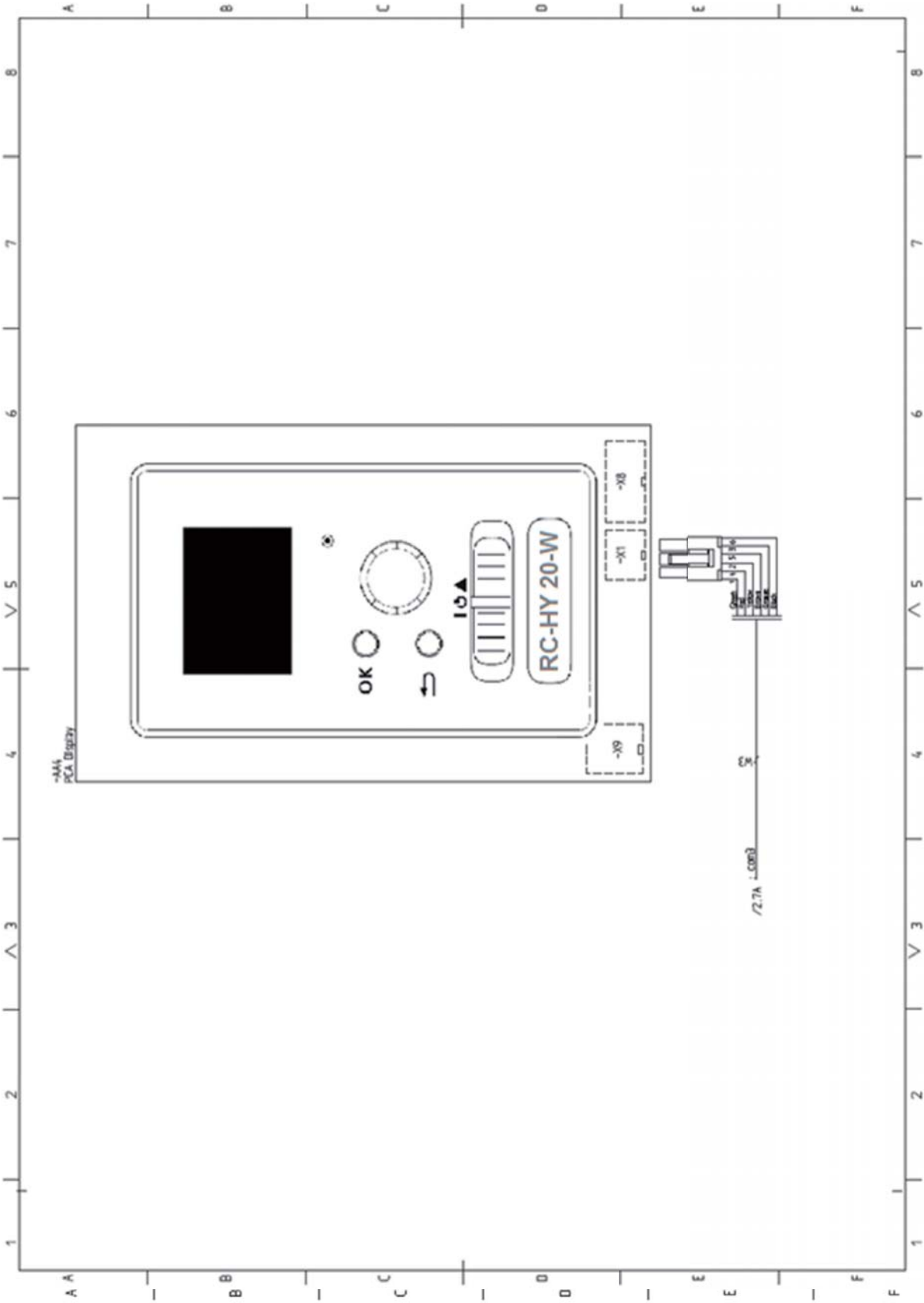

Electric circuit diagram - RC-HY40-W

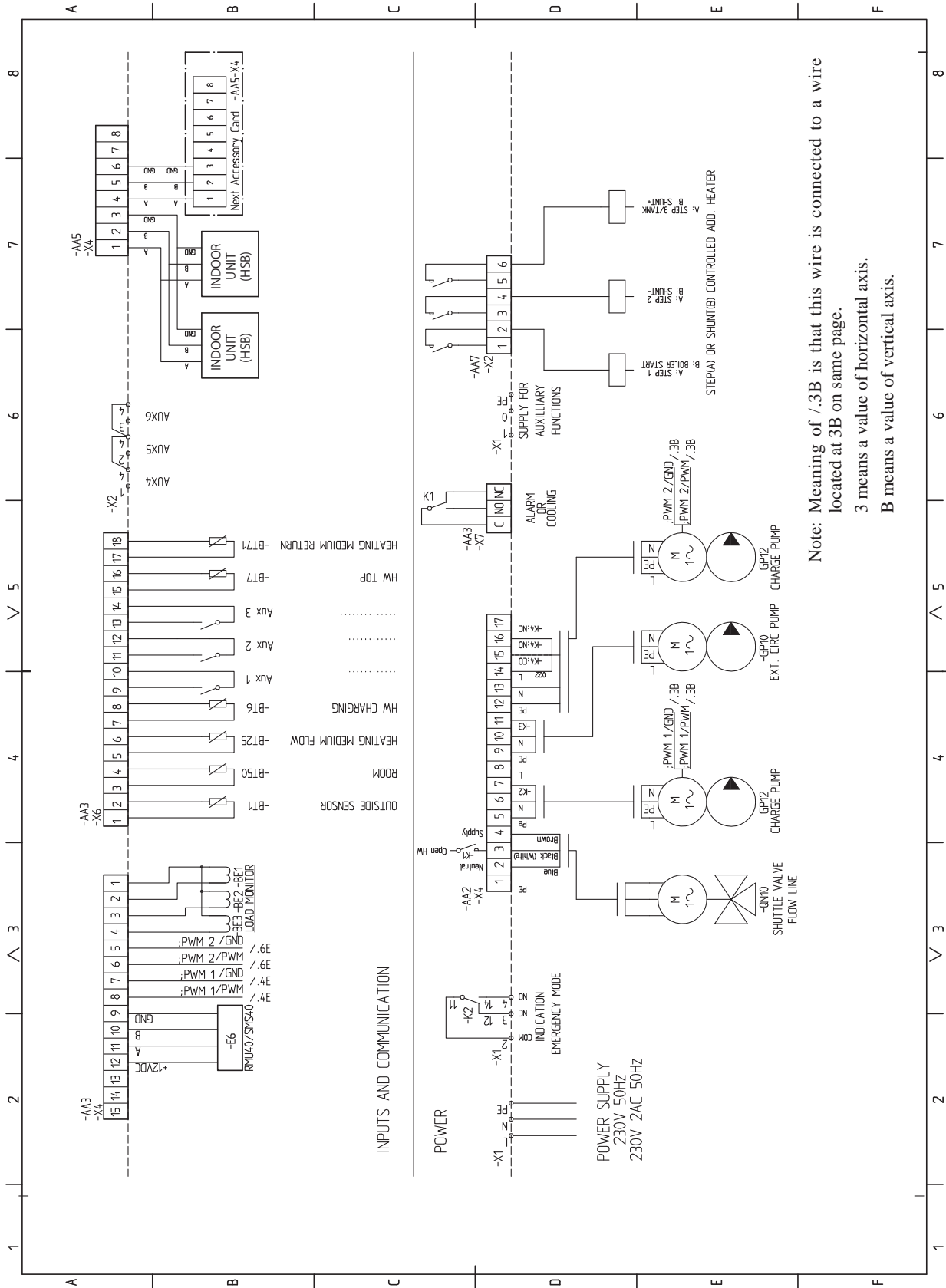

Note: Meaning of /3B is that this wire is connected to a wire located at 3B on same page.
 3 means a value of horizontal axis.
 B means a value of vertical axis.

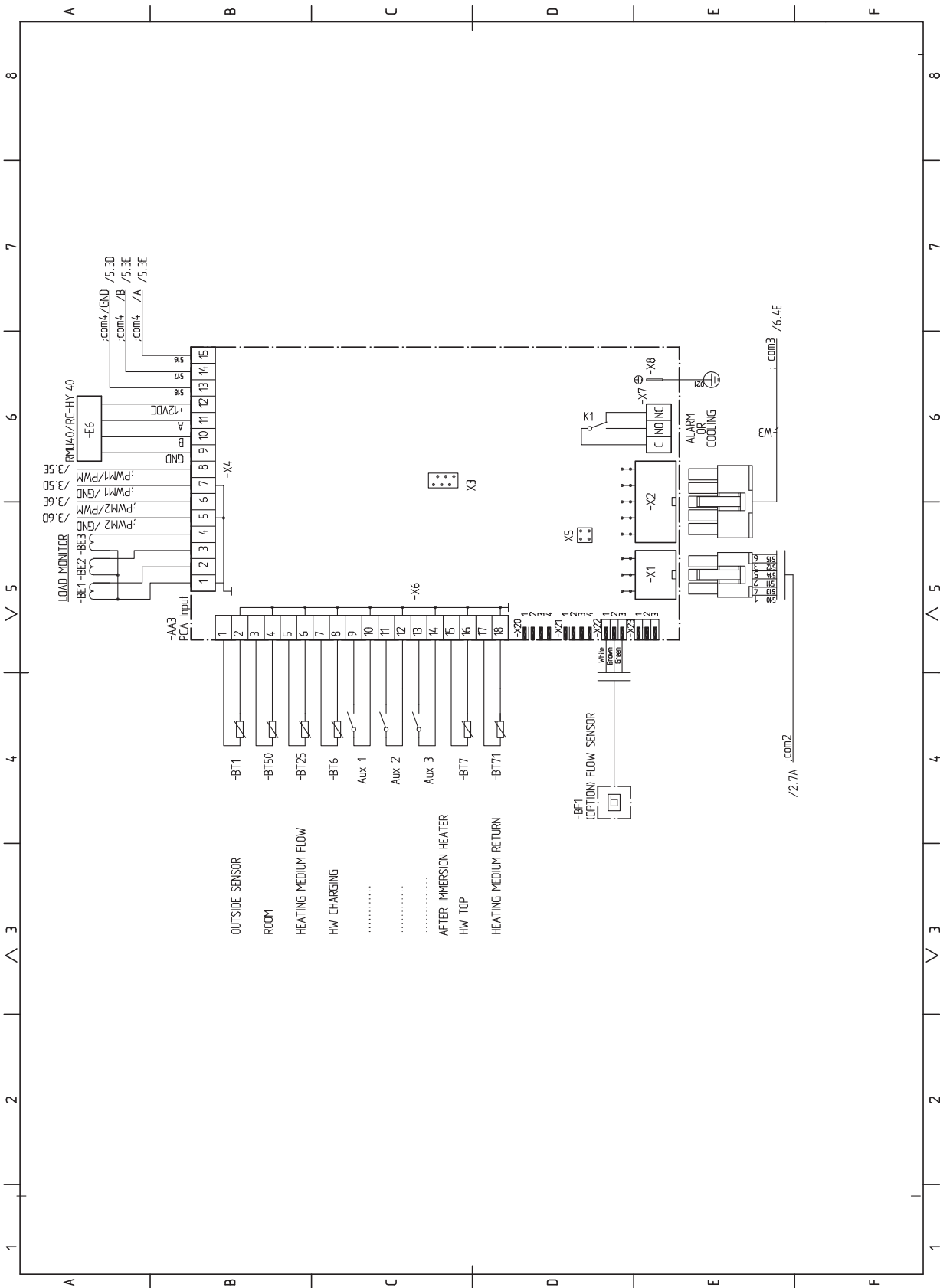

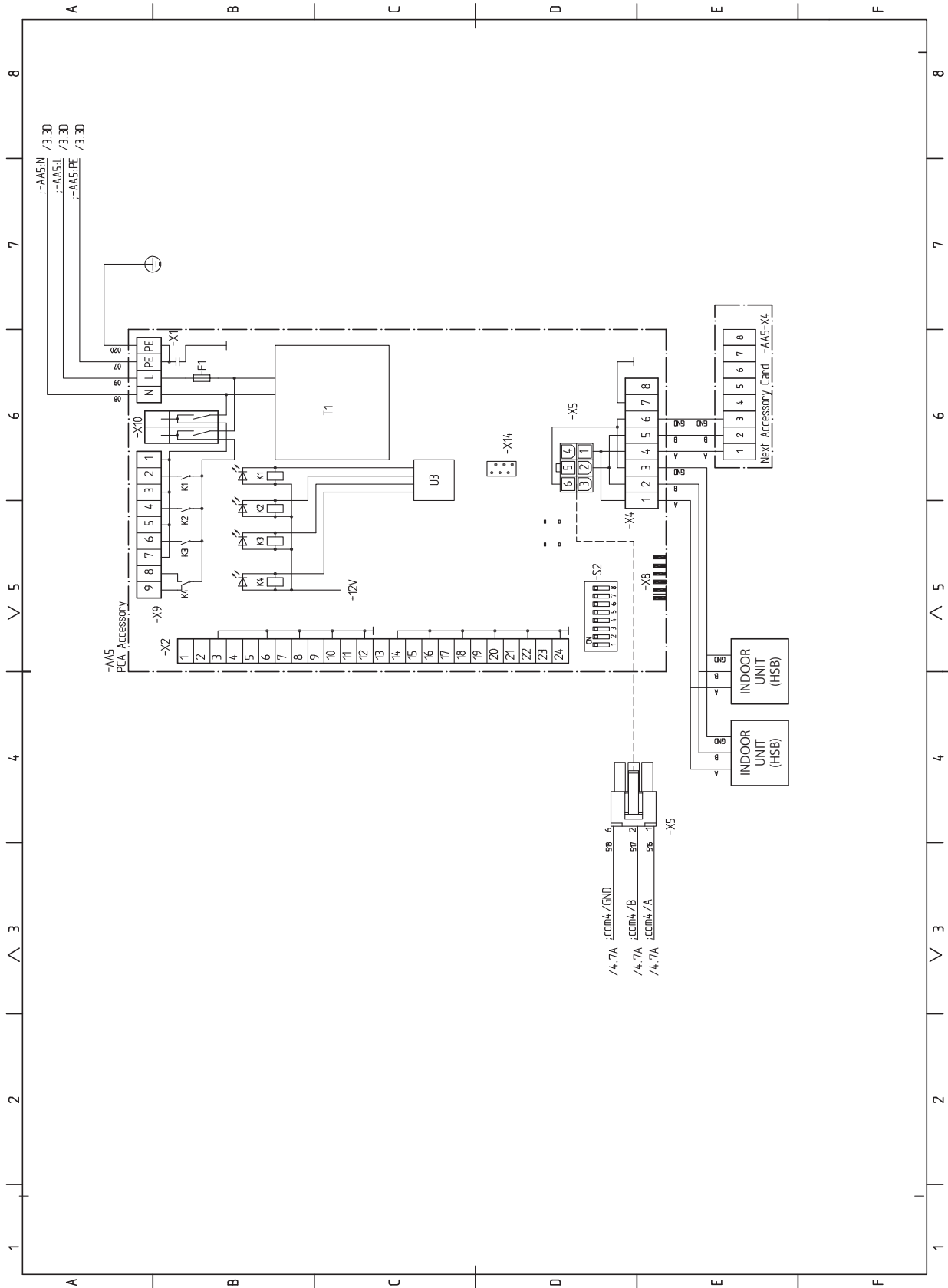

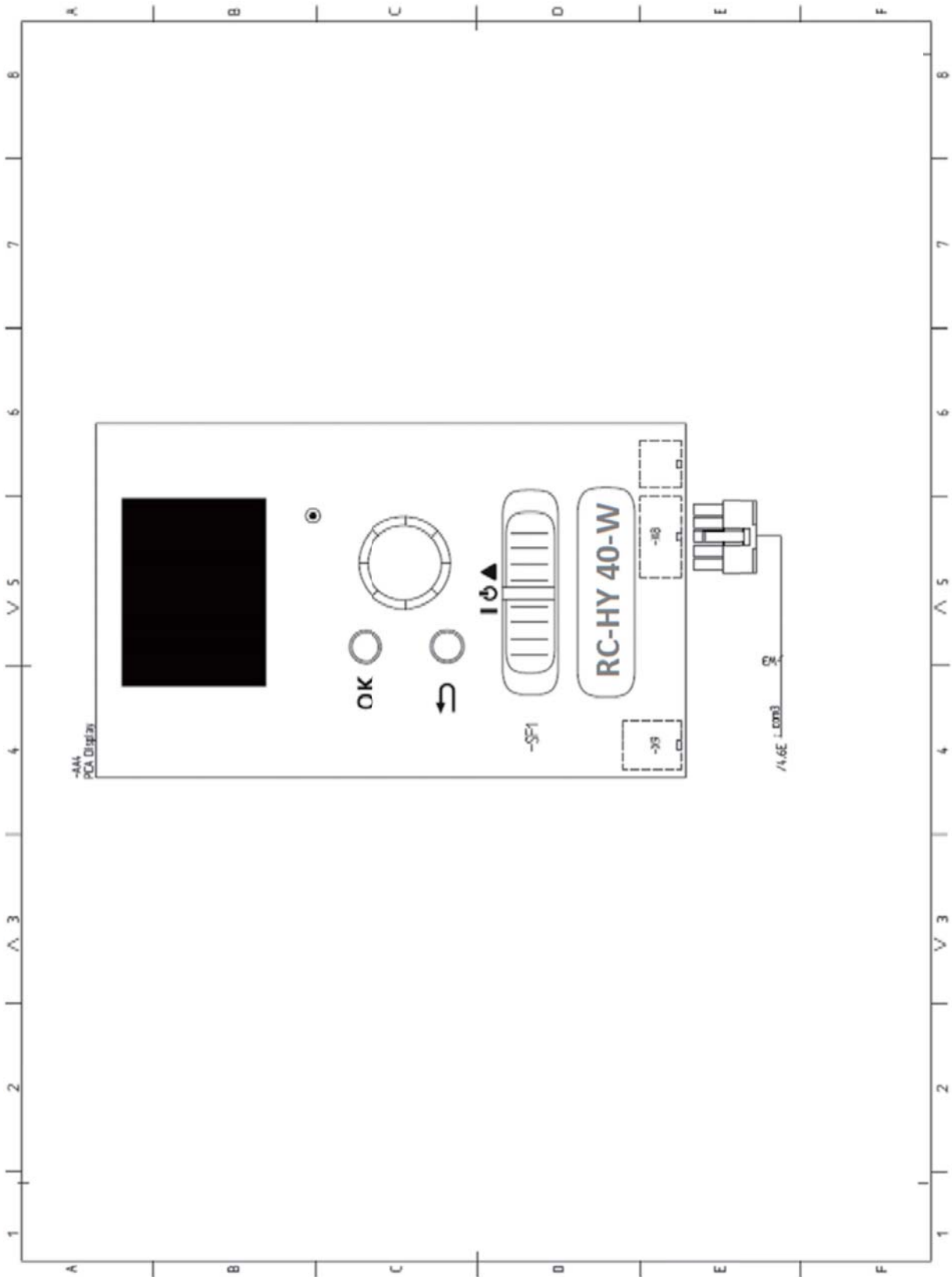



MITSUBISHI HEAVY INDUSTRIES THERMAL SYSTEMS, LTD.

2-3, Marunouchi 3-chome, Chiyoda-ku, Tokyo, 100-8332, Japan
<http://www.mhi-mth.co.jp/>

MITSUBISHI HEAVY INDUSTRIES AIR-CONDITIONING EUROPE, LTD.

5 The Square, Stockley Park, Uxbridge, Middlesex, UB11 1ET, United Kingdom
Tel: +44-333-207-4072
Fax: +44-333-207-4089
<http://www.mhia.com>

MHIAE SERVICES B.V

(Wholly-owned subsidiary of MITSUBISHI HEAVY INDUSTRIES AIR-CONDITIONING EUROPE, LTD)
Herikerbergweg 238, Luna ArenA, 1101 CM Amsterdam, Netherlands
P.O. Box 23393 1100 DW Amsterdam, Netherlands
Tel: +31-20-406-4535
<http://www.mhiaeservices.com>