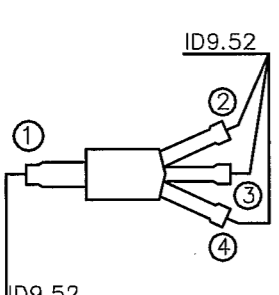
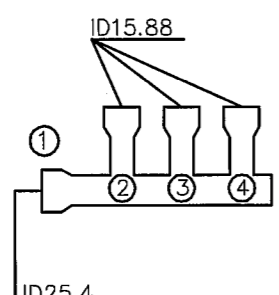
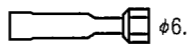
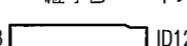
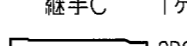
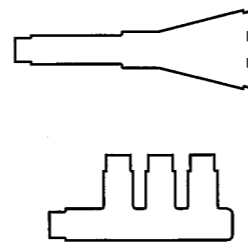

対応室内・室外ユニット組合せ

組合せ	分岐管セット	室外ユニット	室内ユニット容量
トリプル	DIS-TB1G	P224	P80+P80+P80

セット内容

液配管用分岐管	ガス配管用分岐管	異径継手	断熱材
 <p>ID9.52</p> <p>1ヶ</p>	 <p>ID15.88</p> <p>ID25.4</p> <p>1ヶ</p>	<p>継手A 2ヶ</p> <p>ID9.52  φ6.35</p> <p>継手B 1ヶ</p> <p>OD15.88  ID12.7</p> <p>継手C 1ヶ</p> <p>ID12.7  OD9.52</p>	 <p>液・ガス用 各1ヶ</p>

外形図

液配管用分岐管

- ① 室外側接続口 ID9.52
- ② } 室内側接続口 ID9.52
- ③ }
- ④ }

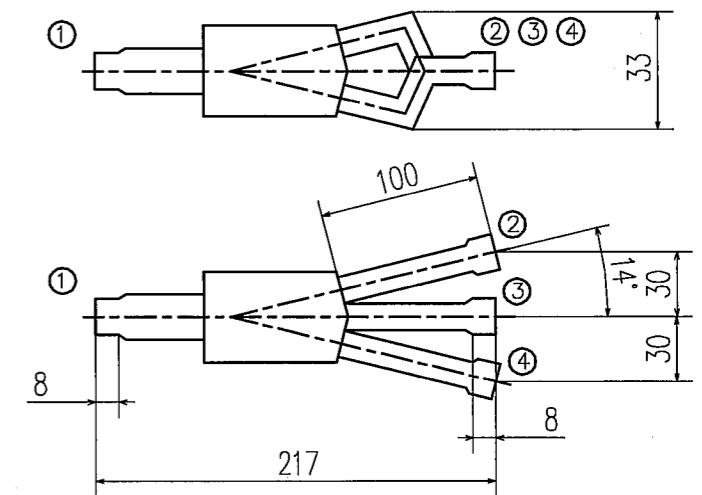

ガス配管用分岐管

- ① 室外側接続口 ID25.4
- ② } 室内側接続口 ID15.88
- ③ }
- ④ }

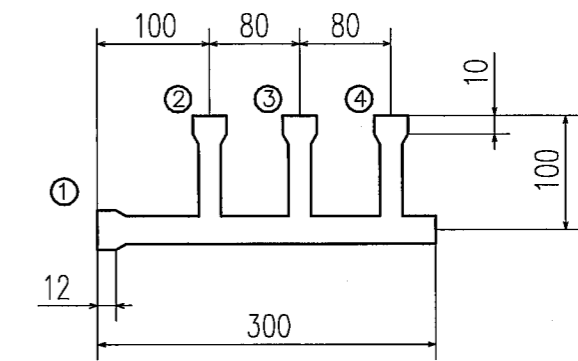

異径継手

A ID9.52

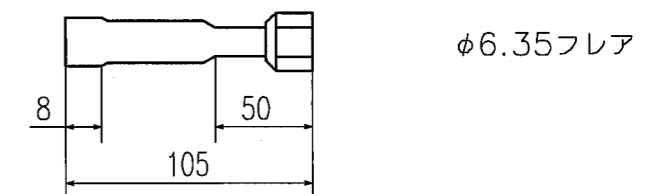

B OD15.88

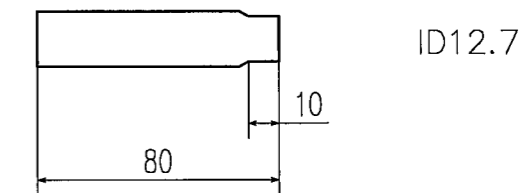

C ID12.7

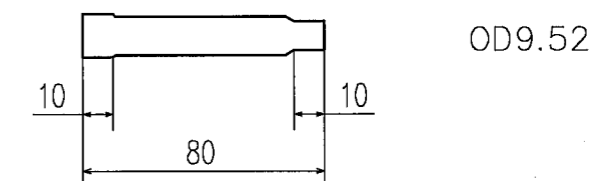

適用機種

形式 DIS-TB1G

発行者 名称 トリプル用
分岐管セット仕様書

小林 図番 PJA003Z393

訂符 葉別
1/1